

## 101805 FAG

Angular contact ball bearings

TYPE: Ball bearings, Angular contact ball bearing, Double row, Hub bearing (unit), FAG production, generation 3

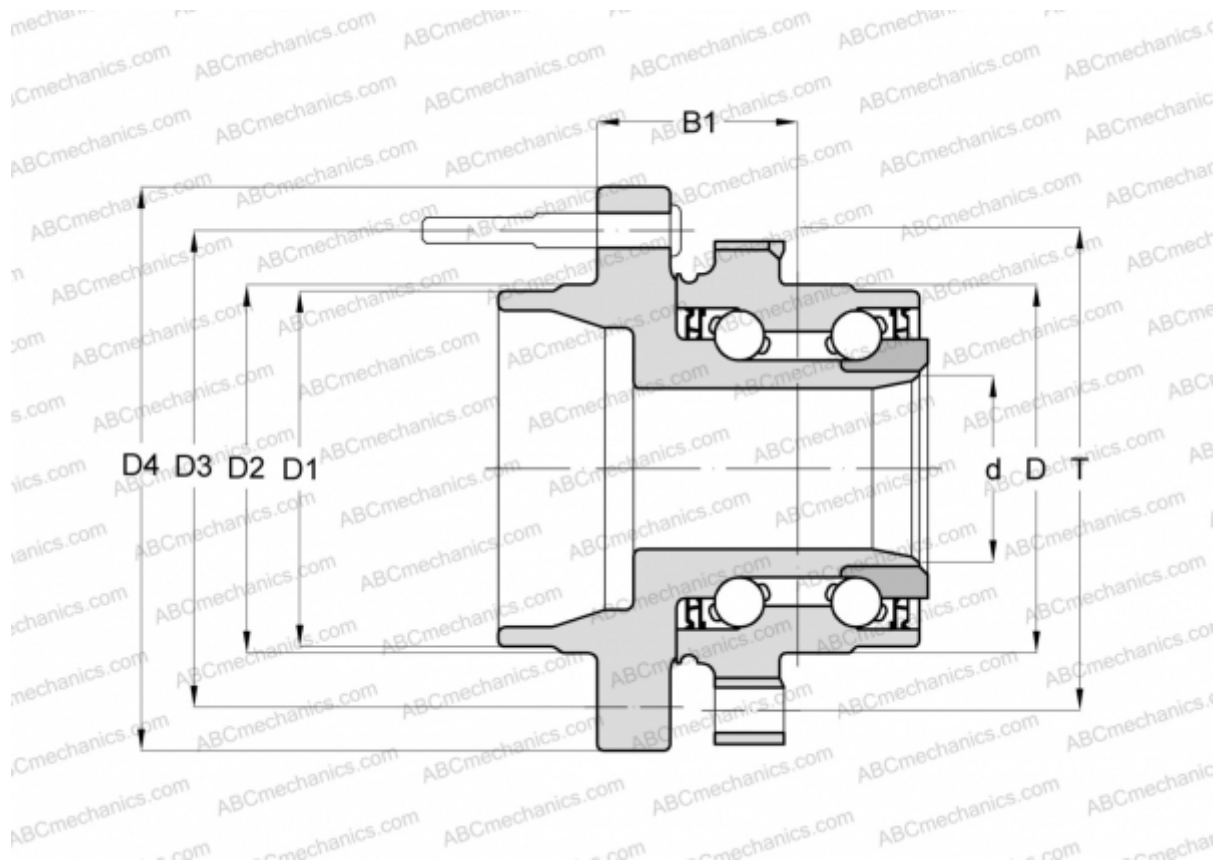

### Technical specification

#### DIMENSIONS, MM

D	74,000
D1	54,000
D2	55,000
D3	100,000
D4	135,000
B1	60,000
T	96,500

#### MANUFACTURER

[FAG](#)