

101813 FAG

Angular contact ball bearings

TYPE: Ball bearings, Angular contact ball bearing, Double row, Hub bearing (unit), FAG production, generation 3

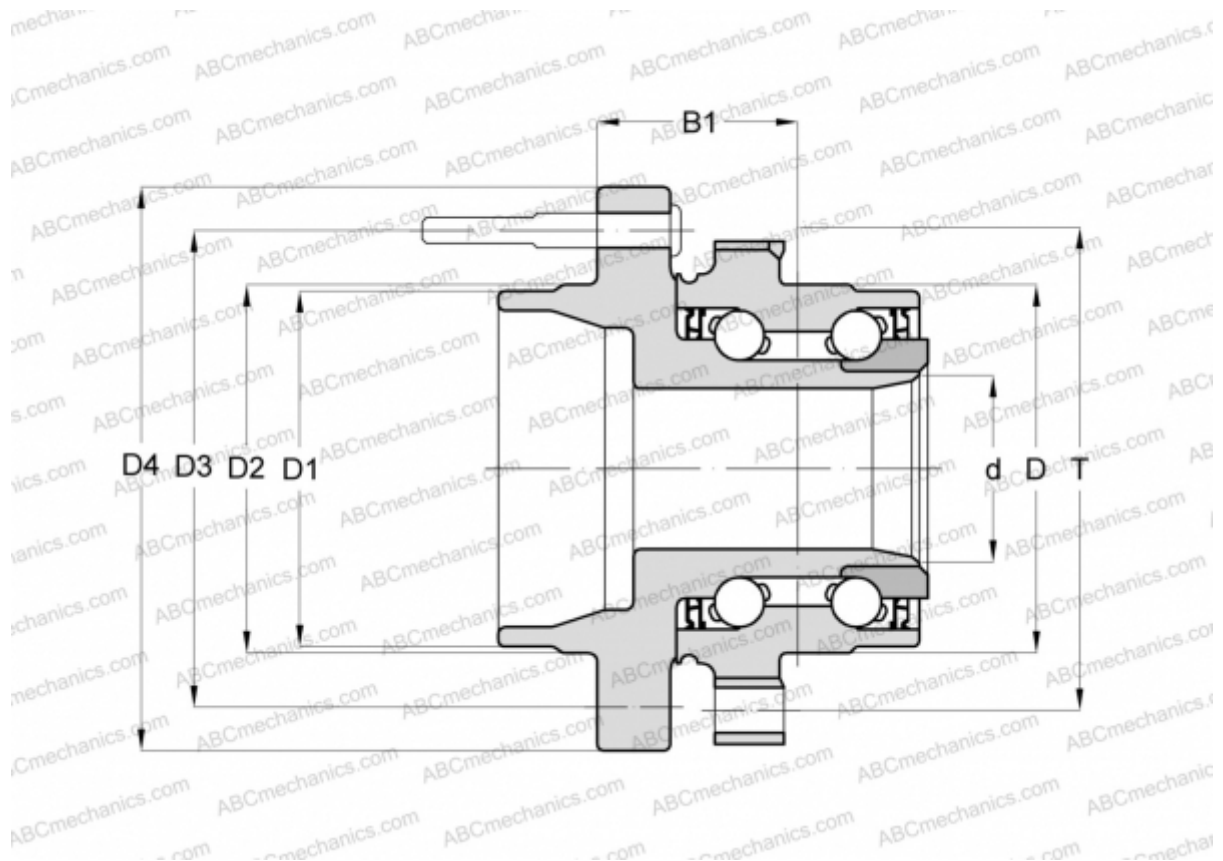

Technical specification

DIMENSIONS, MM

D	88,000
D1	67,900
D2	80,800
D3	114,300
D4	140,500
B1	60,000

MANUFACTURER

[FAG](#)