

## 101877 FAG

Angular contact ball bearings

TYPE: Ball bearings, Angular contact ball bearing, Double row, Hub bearing (unit), FAG production, generation 3

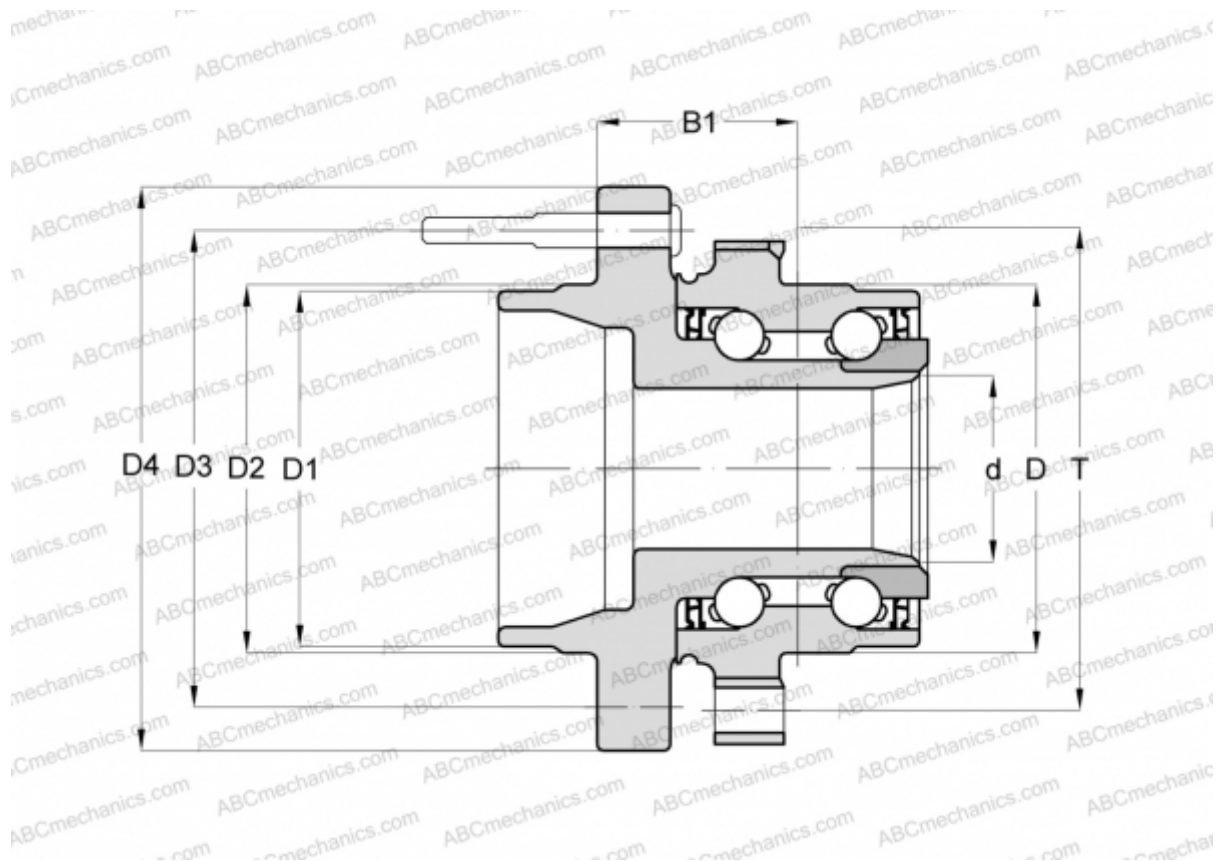

### Technical specification

#### DIMENSIONS, MM

D	82,500
D1	56,450
D2	59,900
D3	105,000
D4	136,000
B1	73,800
T	108,000

#### MANUFACTURER

[FAG](#)