

101902 FAG

Angular contact ball bearings

TYPE: Ball bearings, Angular contact ball bearing, Double row, Hub bearing (unit), FAG production, generation 3

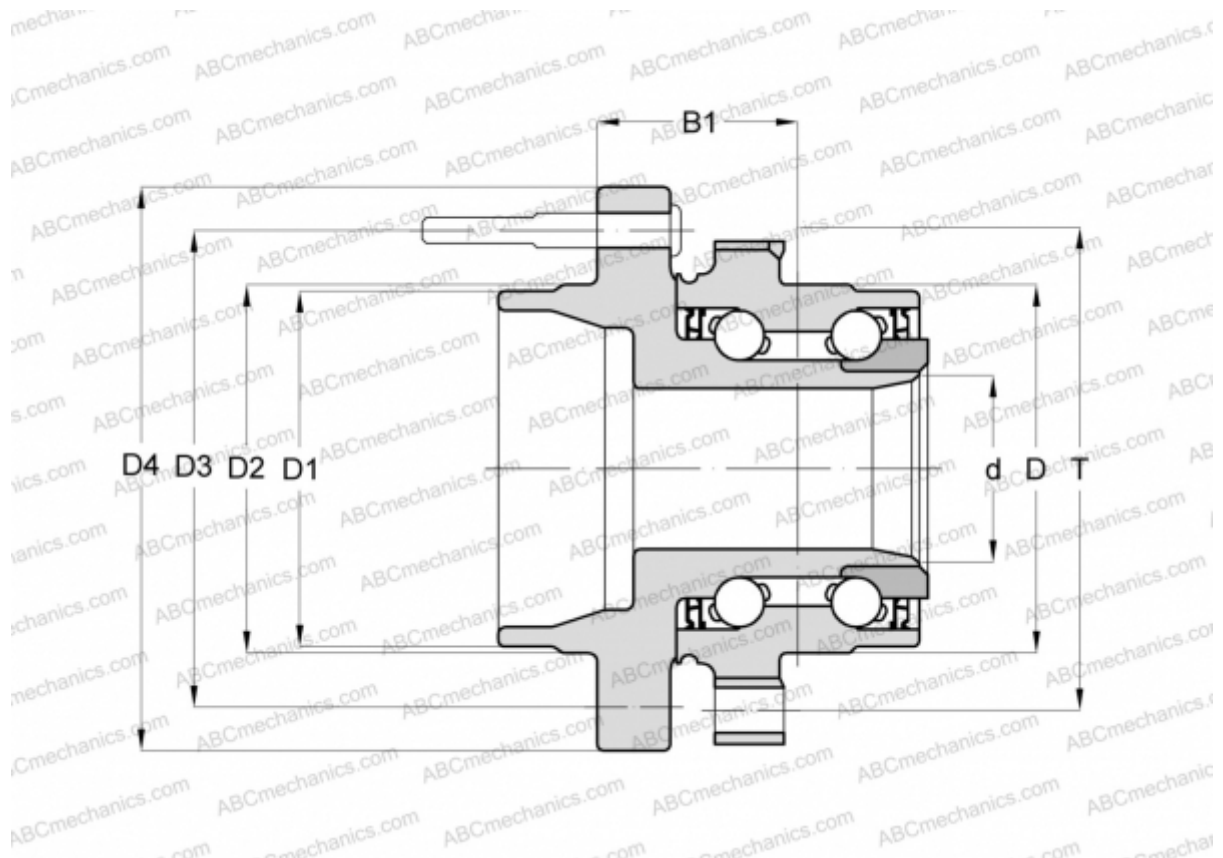

Technical specification

DIMENSIONS, MM

D	68,940
D1	67,240
D2	76,370
D3	114,300
D4	139,030
B1	59,060
T	90,800

MANUFACTURER

[FAG](#)