

101950 FAG

Angular contact ball bearings

TYPE: Ball bearings, Angular contact ball bearing, Double row, Hub bearing (unit), FAG production, generation 3

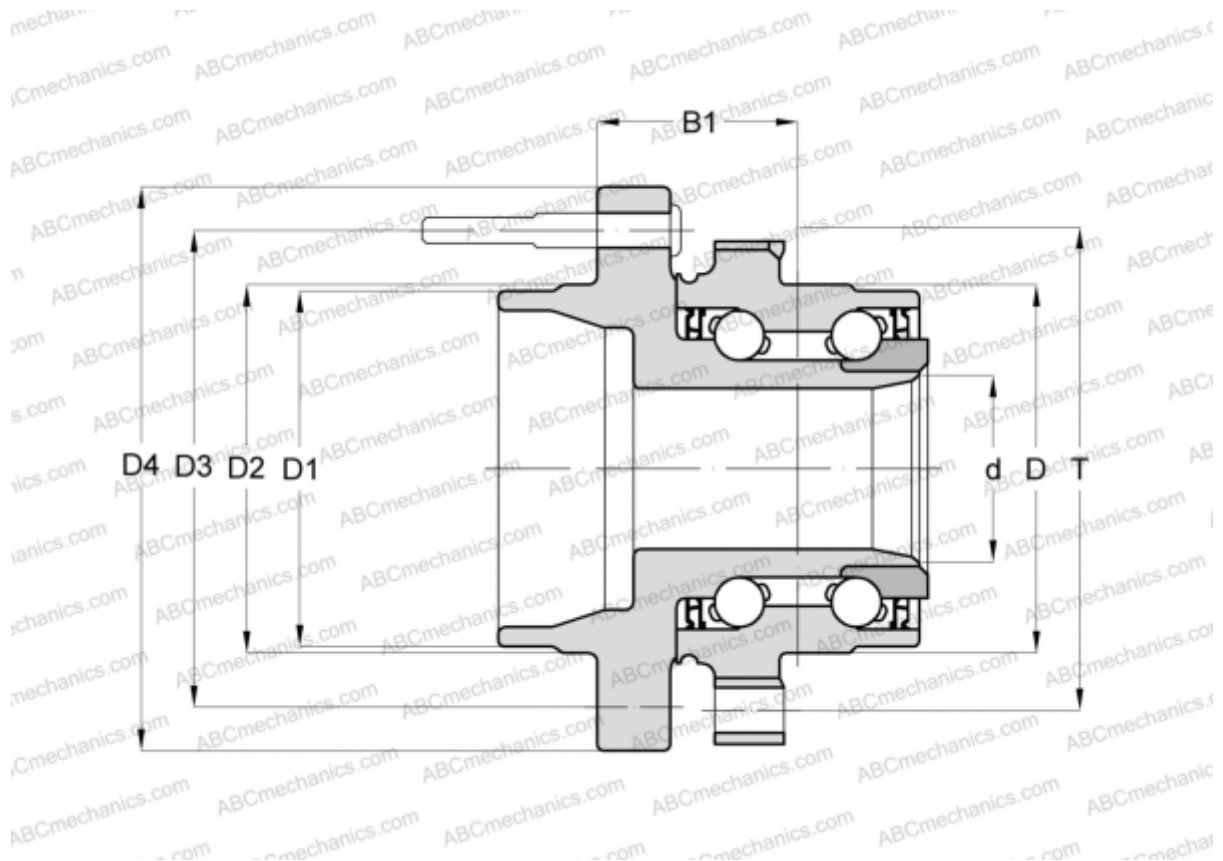

Technical specification

DIMENSIONS, MM

D	64,200
D1	53,890
D2	55,000
D3	105,000
D4	122,000
B1	68,410

MANUFACTURER

[FAG](#)