

101954 FAG

Angular contact ball bearings

TYPE: Ball bearings, Angular contact ball bearing, Double row, Hub bearing (unit), FAG production, generation 3

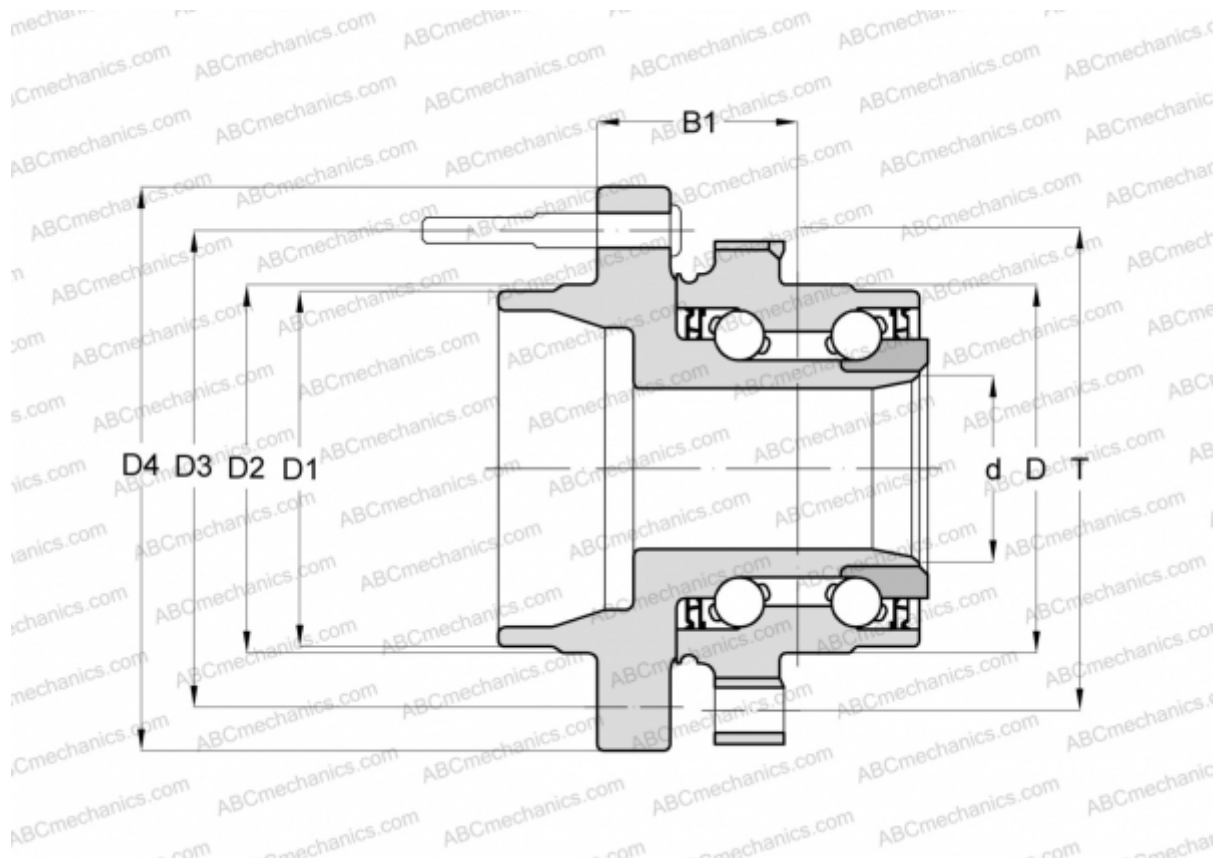

Technical specification

DIMENSIONS, MM

D	73,800
D1	66,950
D2	81,500
D3	114,300
D4	140,500
B1	60,600
T	97,900

MANUFACTURER

[FAG](#)