

101970 FAG

Angular contact ball bearings

TYPE: Ball bearings, Angular contact ball bearing, Double row, Hub bearing (unit), FAG production, generation 3

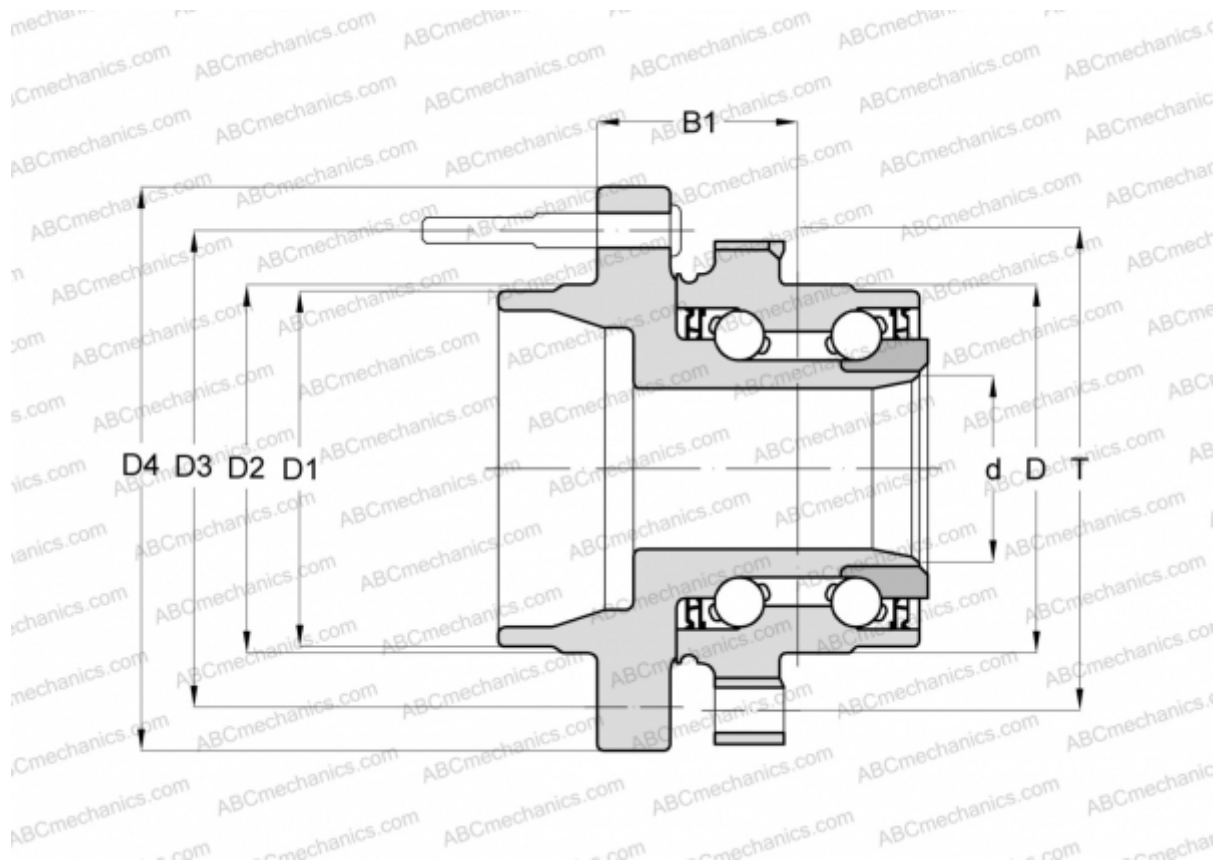

Technical specification

DIMENSIONS, MM

D	100,000
D1	63,780
D2	64,300
D3	114,300
D4	144,500
B1	51,000
T	120,600

MANUFACTURER

[FAG](#)