

101975 FAG

Angular contact ball bearings

TYPE: Ball bearings, Angular contact ball bearing, Double row, Hub bearing (unit), FAG production, generation 3

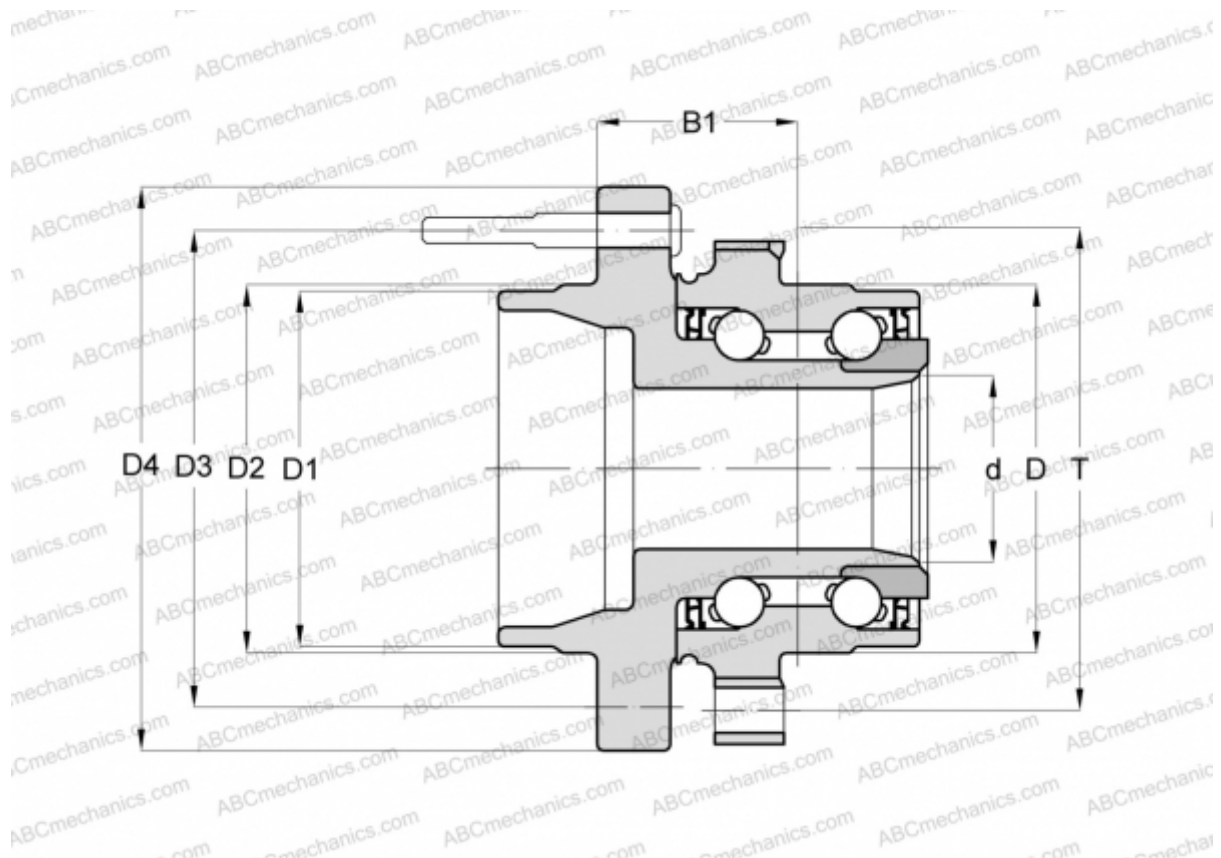

Technical specification

DIMENSIONS, MM

D	89,000
D1	71,300
D2	73,350
D3	114,300
D4	160,300
B1	53,200
T	120,600

MANUFACTURER

[FAG](#)