

## 101977 FAG

Angular contact ball bearings

TYPE: Ball bearings, Angular contact ball bearing, Double row, Hub bearing (unit), FAG production, generation 3

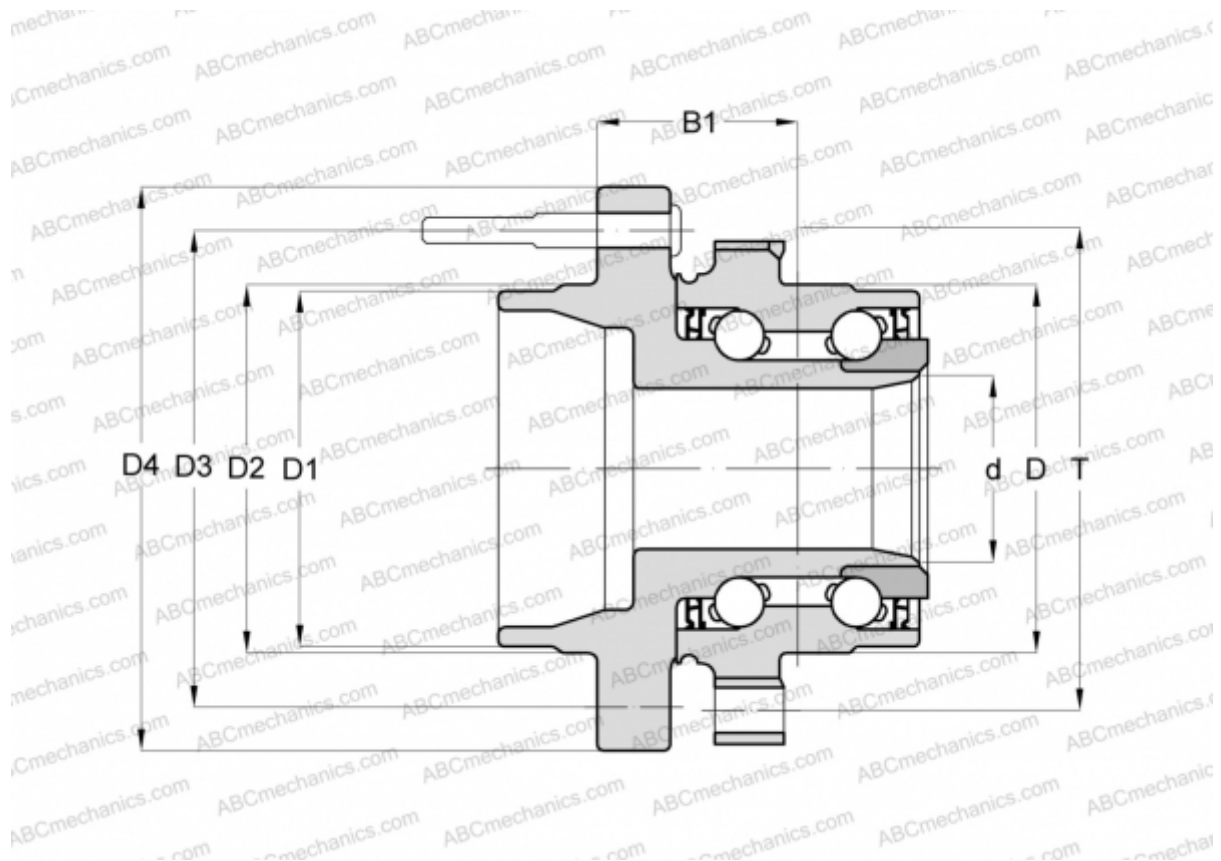

### Technical specification

#### DIMENSIONS, MM

D	89,000
D1	71,400
D2	73,300
D3	114,300
D4	160,500
B1	53,500
T	120,650

#### MANUFACTURER

[FAG](#)