

101978 FAG

Angular contact ball bearings

TYPE: Ball bearings, Angular contact ball bearing, Double row, Hub bearing (unit), FAG production, generation 3

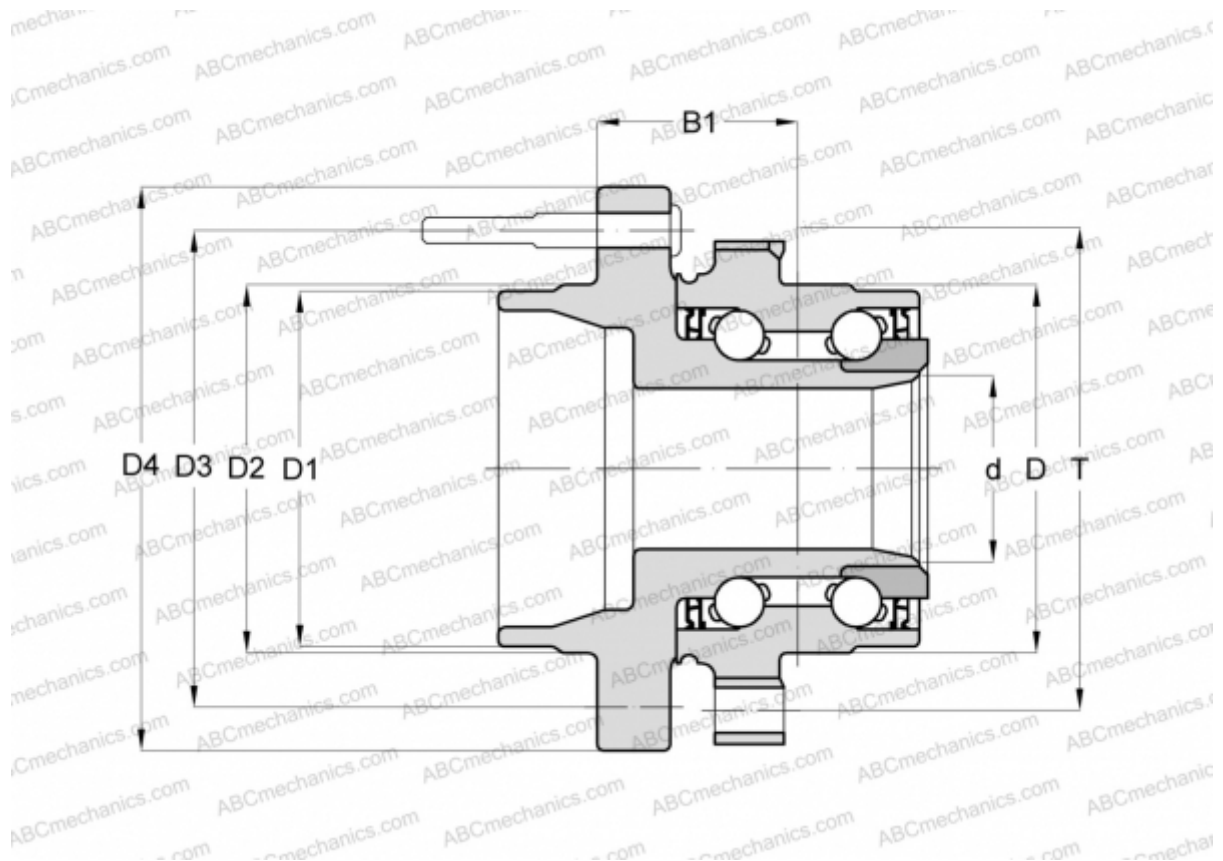

Technical specification

DIMENSIONS, MM

D	99,300
D1	86,800
D2	89,900
D3	135,000
D4	181,500
B1	49,000
T	126,000

MANUFACTURER

[FAG](#)