

101980 FAG

Angular contact ball bearings

TYPE: Ball bearings, Angular contact ball bearing, Double row, Hub bearing (unit), FAG production, generation 3

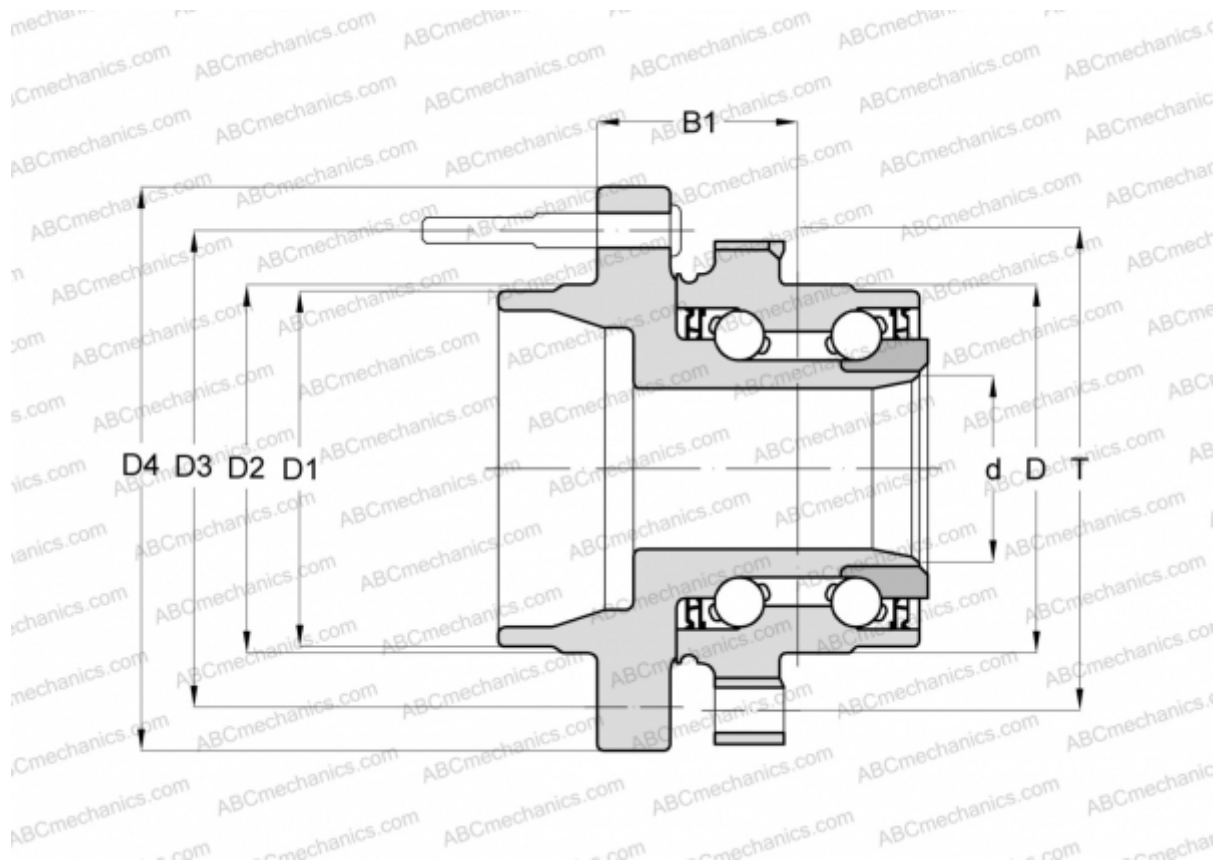

Technical specification

DIMENSIONS, MM

D	99,300
D1	100,300
D2	121,000
D3	165,100
D4	208,000
B1	55,900
T	126,000

MANUFACTURER

[FAG](#)