

101982 FAG

Angular contact ball bearings

TYPE: Ball bearings, Angular contact ball bearing, Double row, Hub bearing (unit), FAG production, generation 3

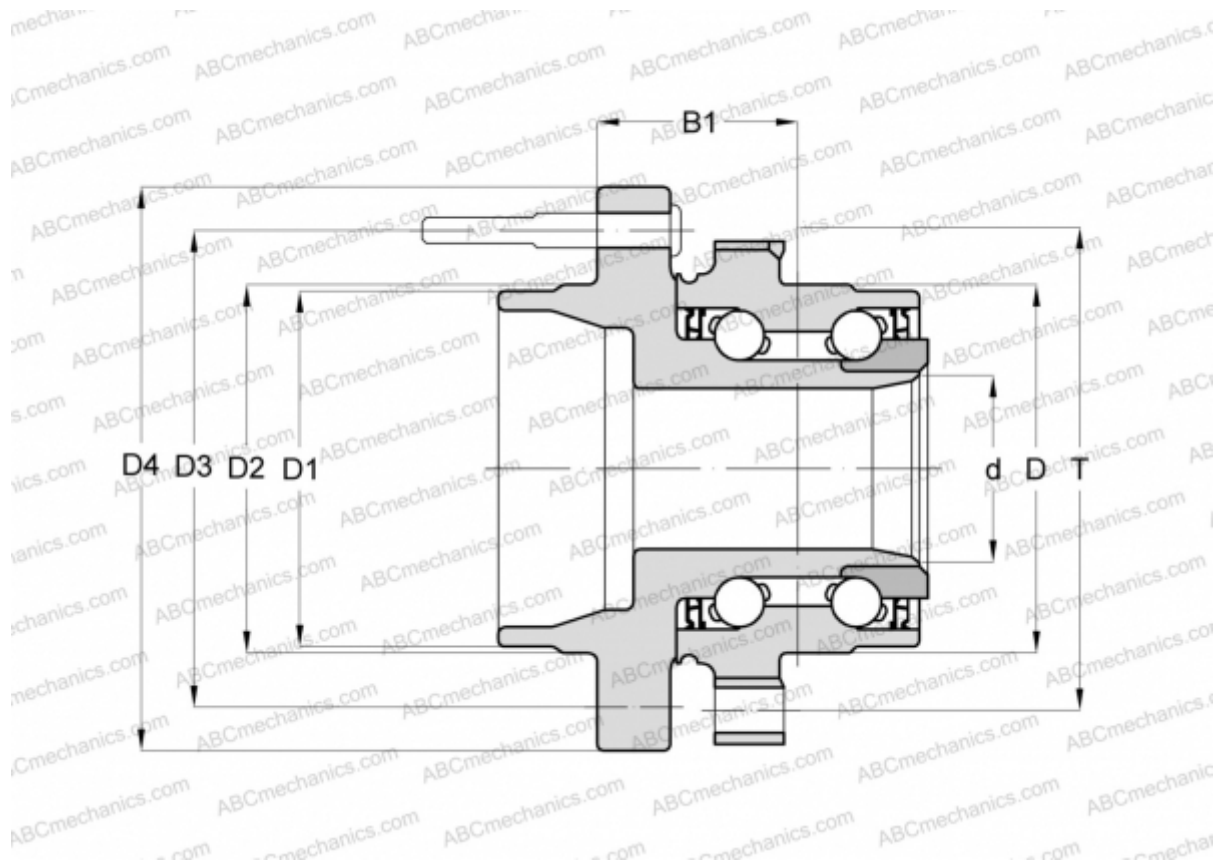

Technical specification

DIMENSIONS, MM

D	100,000
D1	70,610
D2	72,000
D3	114,300
D4	149,500
B1	56,200
T	120,650

MANUFACTURER

[FAG](#)