

101987 FAG

Angular contact ball bearings

TYPE: Ball bearings, Angular contact ball bearing, Double row, Hub bearing (unit), FAG production, generation 3

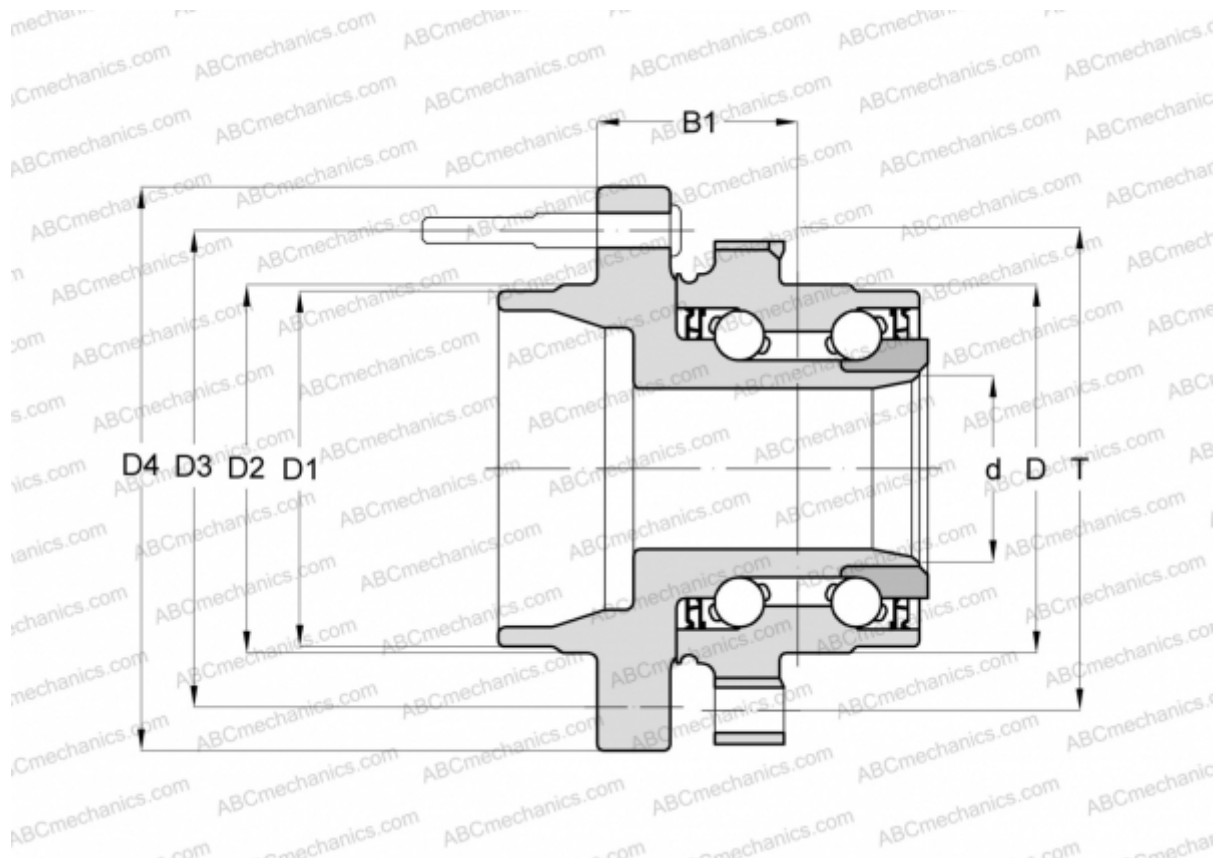

Technical specification

DIMENSIONS, MM

D	99,300
D1	77,600
D2	78,400
D3	139,700
D4	182,200
B1	56,750
T	127,000

MANUFACTURER

[FAG](#)