

102005 FAG

Angular contact ball bearings

TYPE: Ball bearings, Angular contact ball bearing, Double row, Hub bearing (unit), FAG production, generation 3

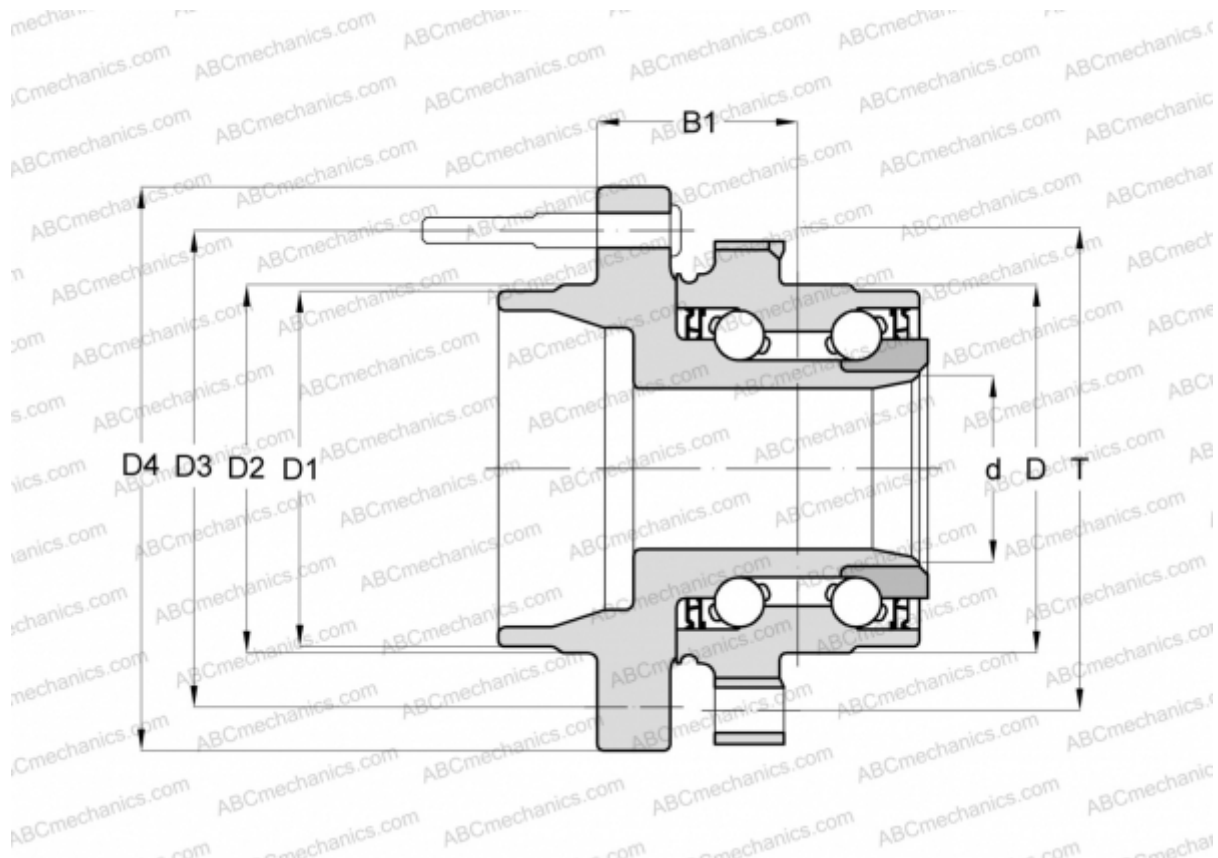

Technical specification

DIMENSIONS, MM

D	113,800
D1	120,950
D2	122,100
D3	165,100
D4	205,000
B1	54,300
T	140,000

MANUFACTURER

[FAG](#)