

102014 FAG

Angular contact ball bearings

TYPE: Ball bearings, Angular contact ball bearing, Double row, Hub bearing (unit), FAG production, generation 3

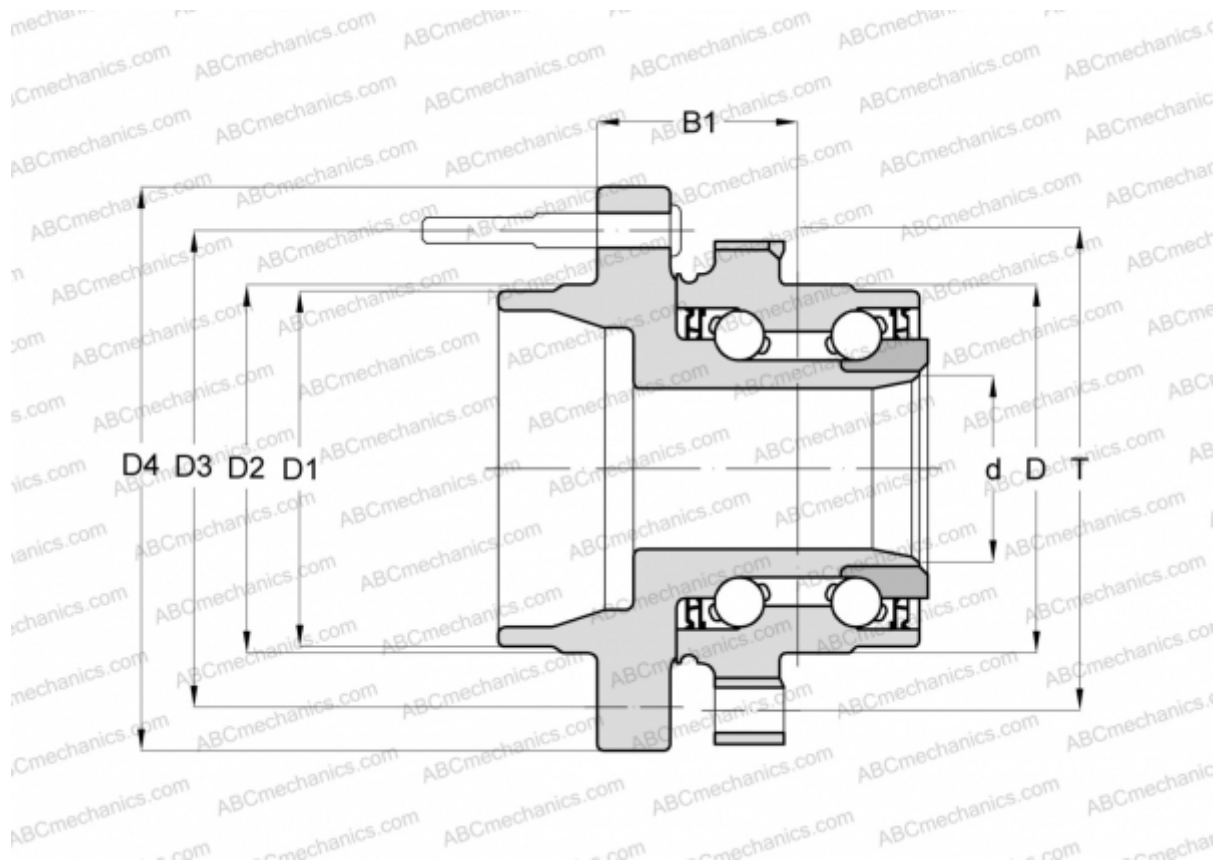

Technical specification

DIMENSIONS, MM

D	85,000
D1	70,500
D2	82,000
D3	114,300
D4	160,000
B1	48,400
T	110,000

MANUFACTURER

[FAG](#)