

102020 FAG

Angular contact ball bearings

TYPE: Ball bearings, Angular contact ball bearing, Double row, Hub bearing (unit), FAG production, generation 3

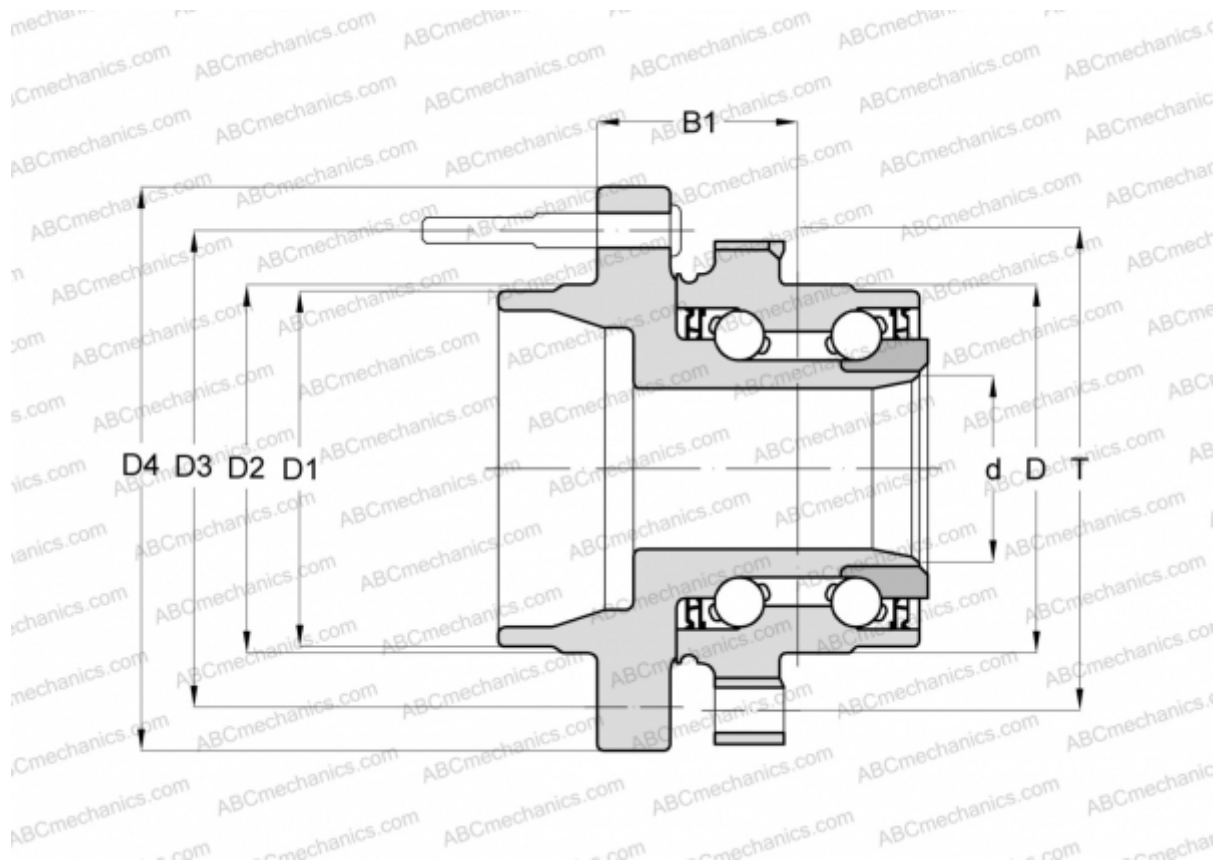

Technical specification

DIMENSIONS, MM

D	105,800
D1	116,700
D2	117,800
D3	165,100
D4	199,300
B1	57,800
T	140,000

MANUFACTURER

[FAG](#)