

102028 FAG

Angular contact ball bearings

TYPE: Ball bearings, Angular contact ball bearing, Double row, Hub bearing (unit), FAG production, generation 3

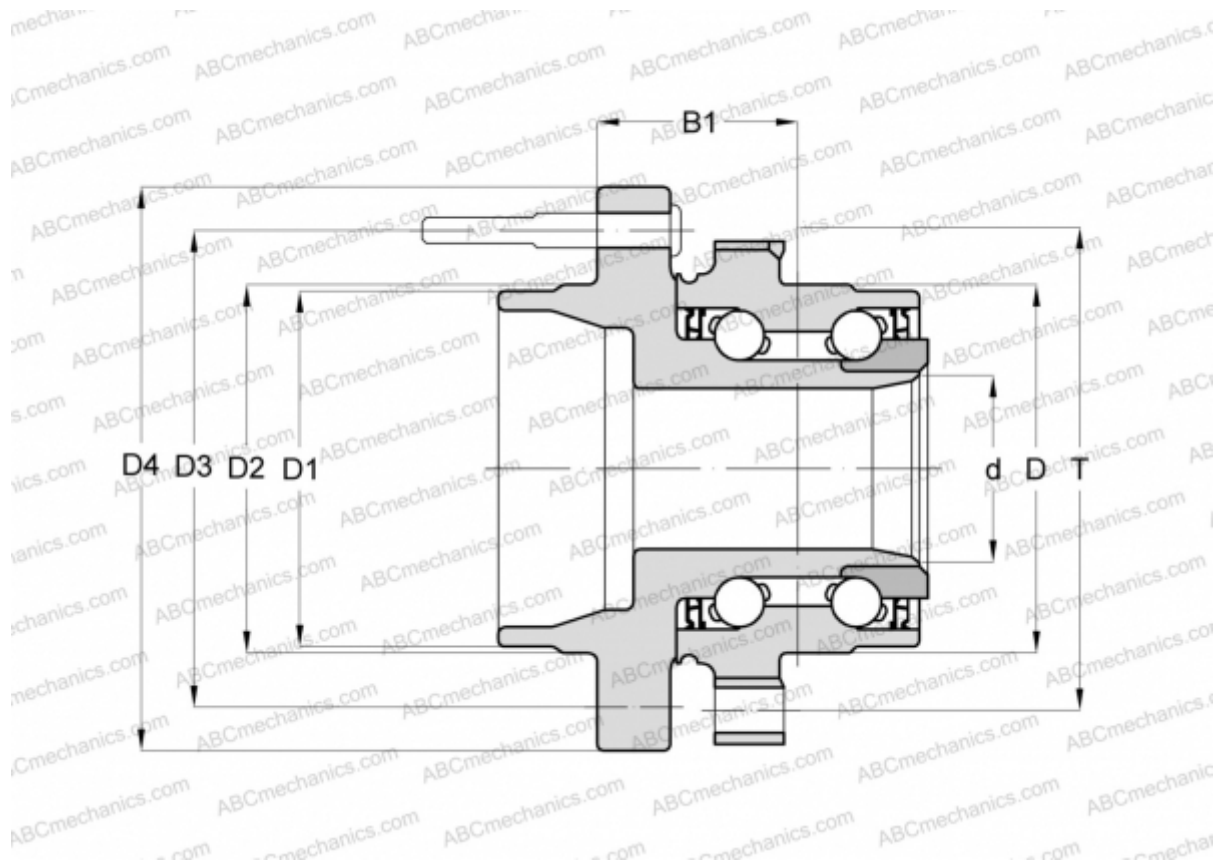

Technical specification

DIMENSIONS, MM

D	87,000
D1	71,320
D2	73,250
D3	73,250
D4	139,000
B1	37,500
T	112,000

MANUFACTURER

[FAG](#)