

102032 FAG

Angular contact ball bearings

TYPE: Ball bearings, Angular contact ball bearing, Double row, Hub bearing (unit), FAG production, generation 3

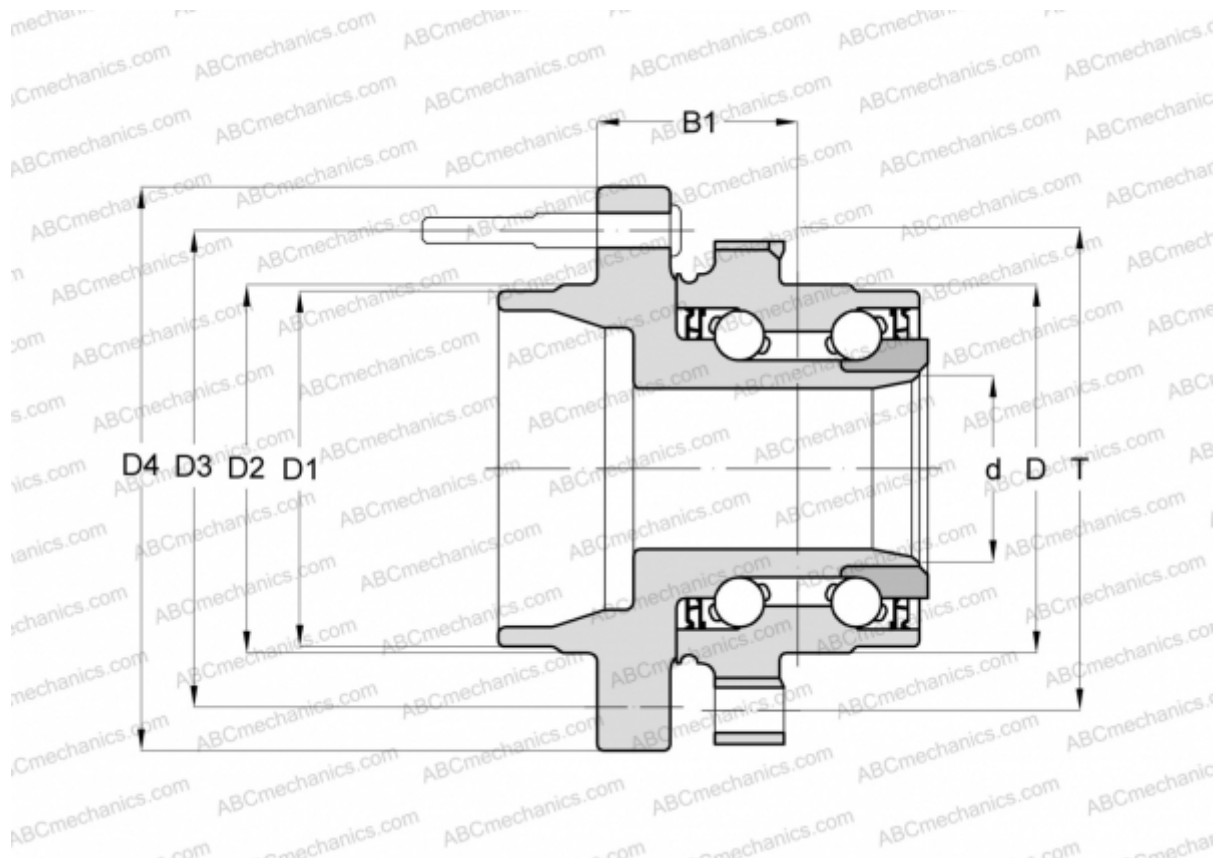

Technical specification

DIMENSIONS, MM

D	84,000
D1	67,000
D2	68,900
D3	114,300
D4	142,000
B1	40,500
T	105,900

MANUFACTURER

[FAG](#)