

102033 FAG

Angular contact ball bearings

TYPE: Ball bearings, Angular contact ball bearing, Double row, Hub bearing (unit), FAG production, generation 3

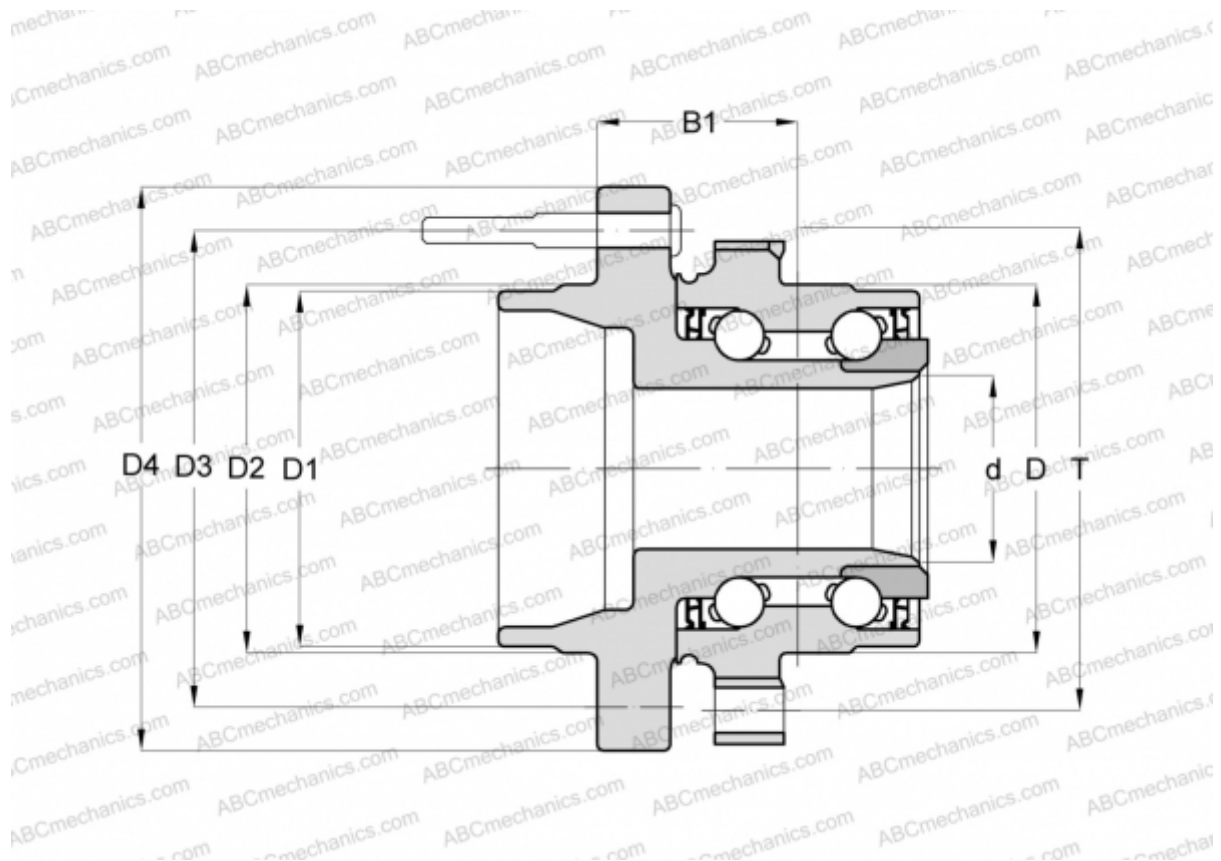

Technical specification

DIMENSIONS, MM

D	91,800
D1	77,880
D2	78,950
D3	127,000
D4	150,500
B1	47,000
T	120,600

MANUFACTURER

[FAG](#)