

## 102040 FAG

Angular contact ball bearings

TYPE: Ball bearings, Angular contact ball bearing, Double row, Hub bearing (unit), FAG production, generation 3

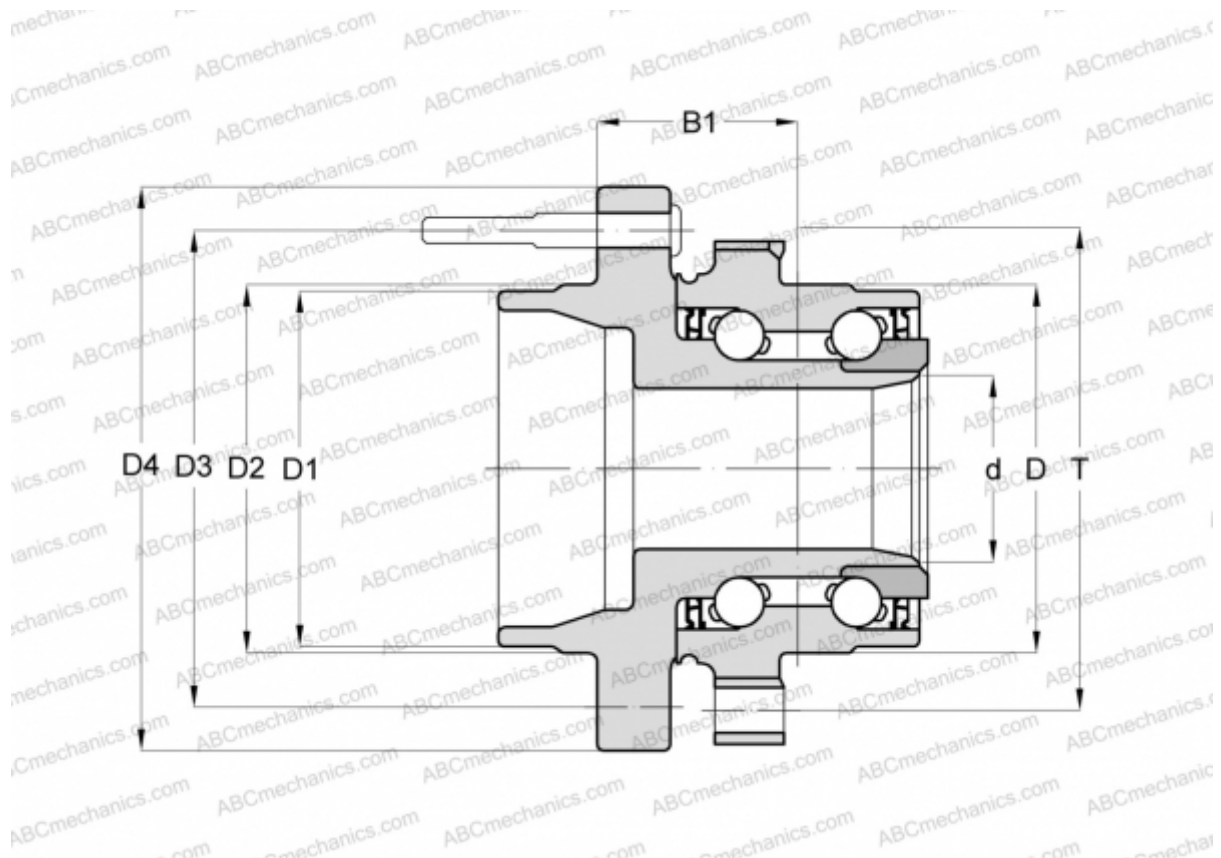

### Technical specification

#### DIMENSIONS, MM

D	85,000
D1	65,000
D2	65,400
D3	110,000
D4	136,900
B1	39,000
T	110,000

#### MANUFACTURER

[FAG](#)