

## 102041 FAG

Angular contact ball bearings

TYPE: Ball bearings, Angular contact ball bearing, Double row, Hub bearing (unit), FAG production, generation 3

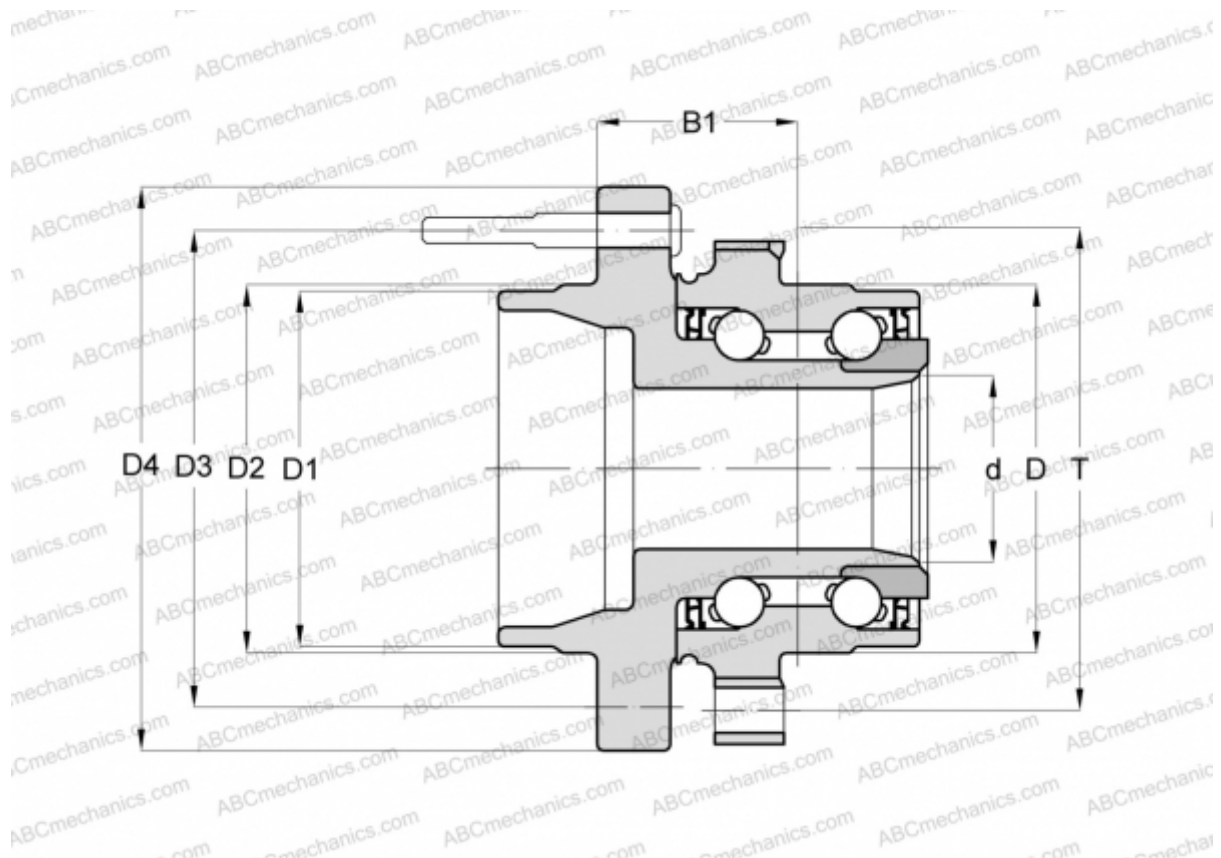

### Technical specification

#### DIMENSIONS, MM

D	105,000
D1	77,700
D2	78,400
D3	139,700
D4	183,000
B1	48,800
T	133,000

#### MANUFACTURER

[FAG](#)