

## 102043 FAG

Angular contact ball bearings

TYPE: Ball bearings, Angular contact ball bearing, Double row, Hub bearing (unit), FAG production, generation 3

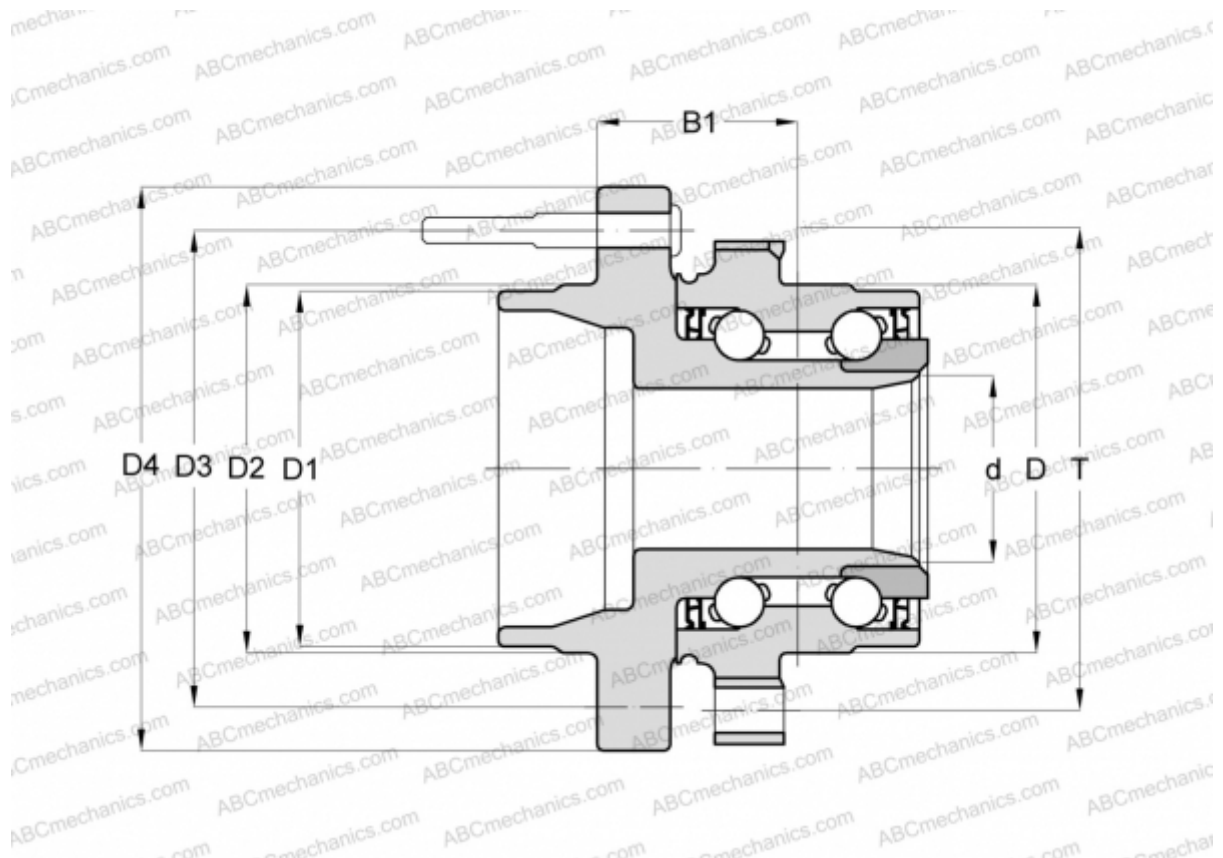

### Technical specification

#### DIMENSIONS, MM

D	87,000
D1	67,000
D2	69,000
D3	114,300
D4	142,000
B1	40,500
T	112,300

#### MANUFACTURER

[FAG](#)