

102049 FAG

Angular contact ball bearings

TYPE: Ball bearings, Angular contact ball bearing, Double row, Hub bearing (unit), FAG production, generation 3

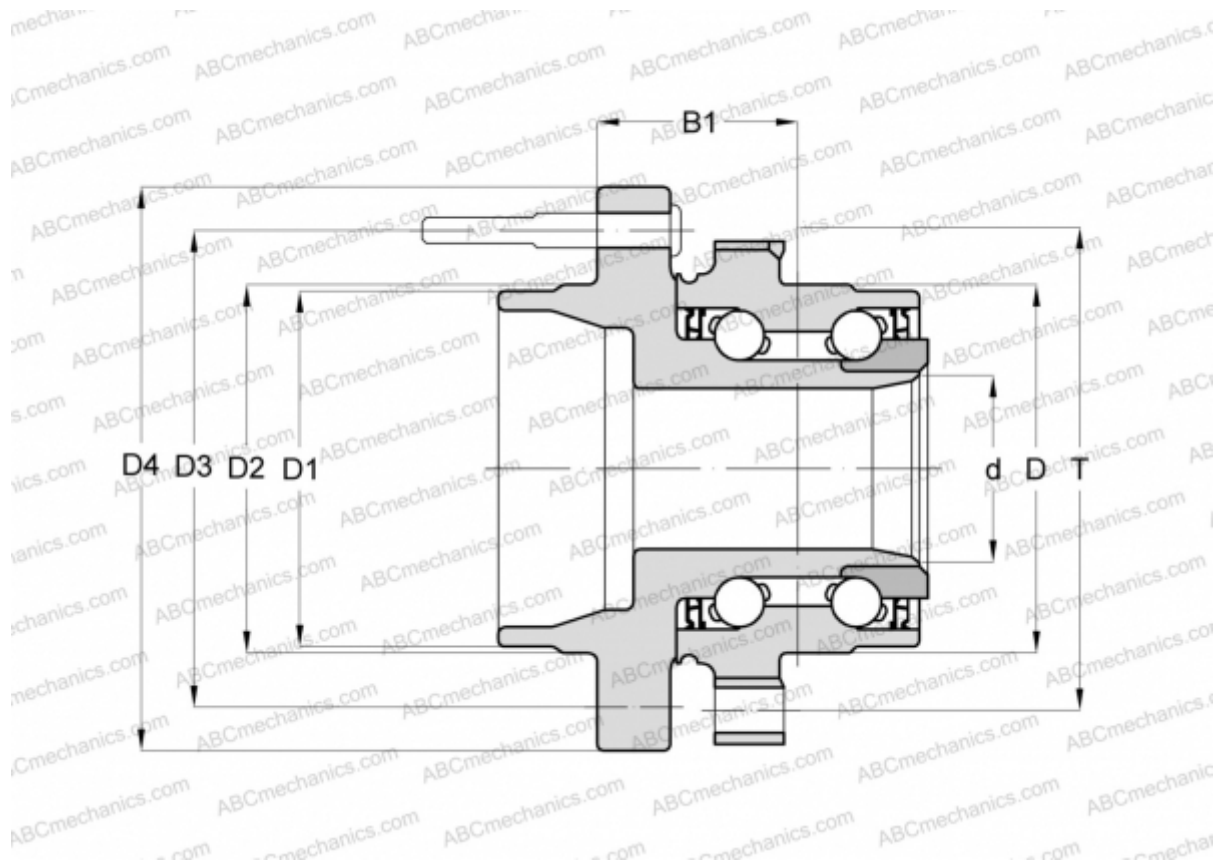

Technical specification

DIMENSIONS, MM

D	91,450
D1	63,300
D2	71,000
D3	114,300
D4	156,000
B1	41,500
T	114,000

MANUFACTURER

[FAG](#)