

102051 FAG

Angular contact ball bearings

TYPE: Ball bearings, Angular contact ball bearing, Double row, Hub bearing (unit), FAG production, generation 3

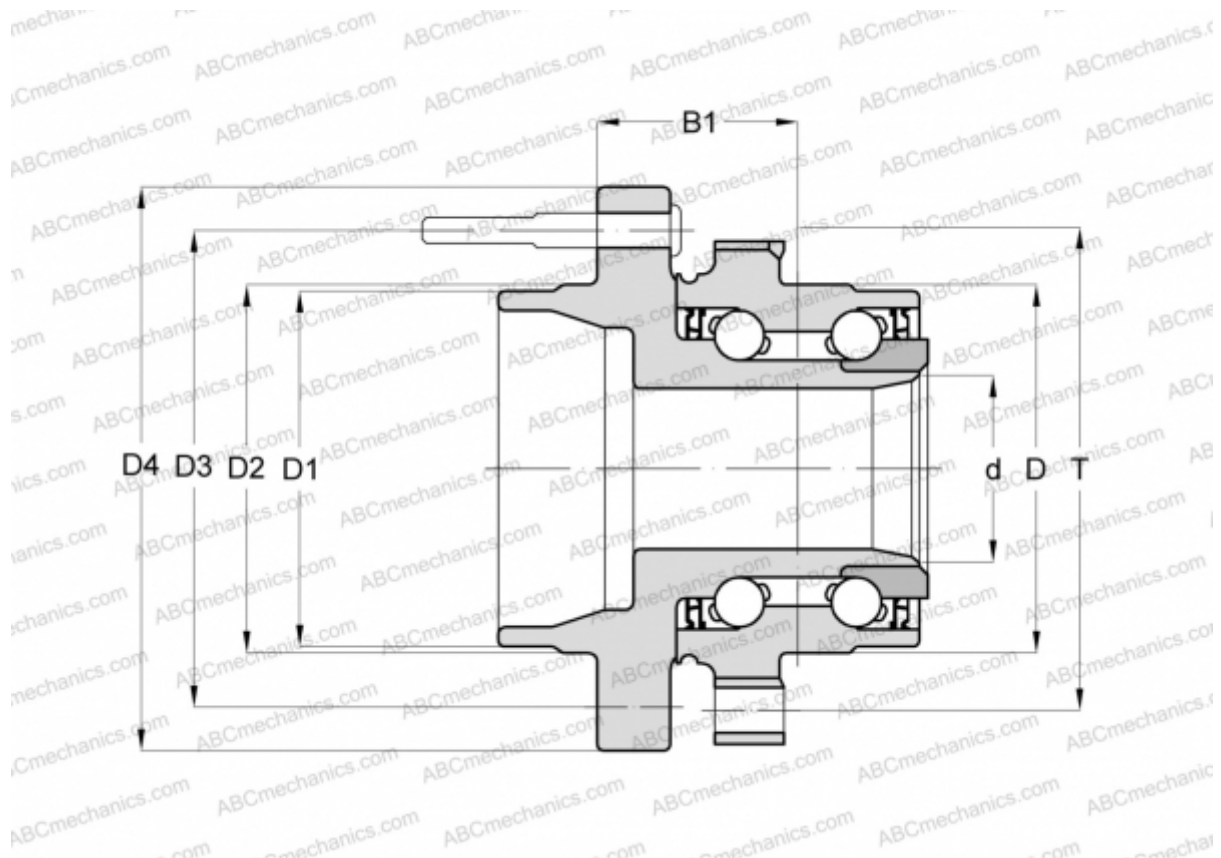

Technical specification

DIMENSIONS, MM

D	85,000
D1	67,000
D2	69,000
D3	114,300
D4	141,500
B1	48,500
T	110,000

MANUFACTURER

[FAG](#)