

## 102054 FAG

Angular contact ball bearings

TYPE: Ball bearings, Angular contact ball bearing, Double row, Hub bearing (unit), FAG production, generation 3

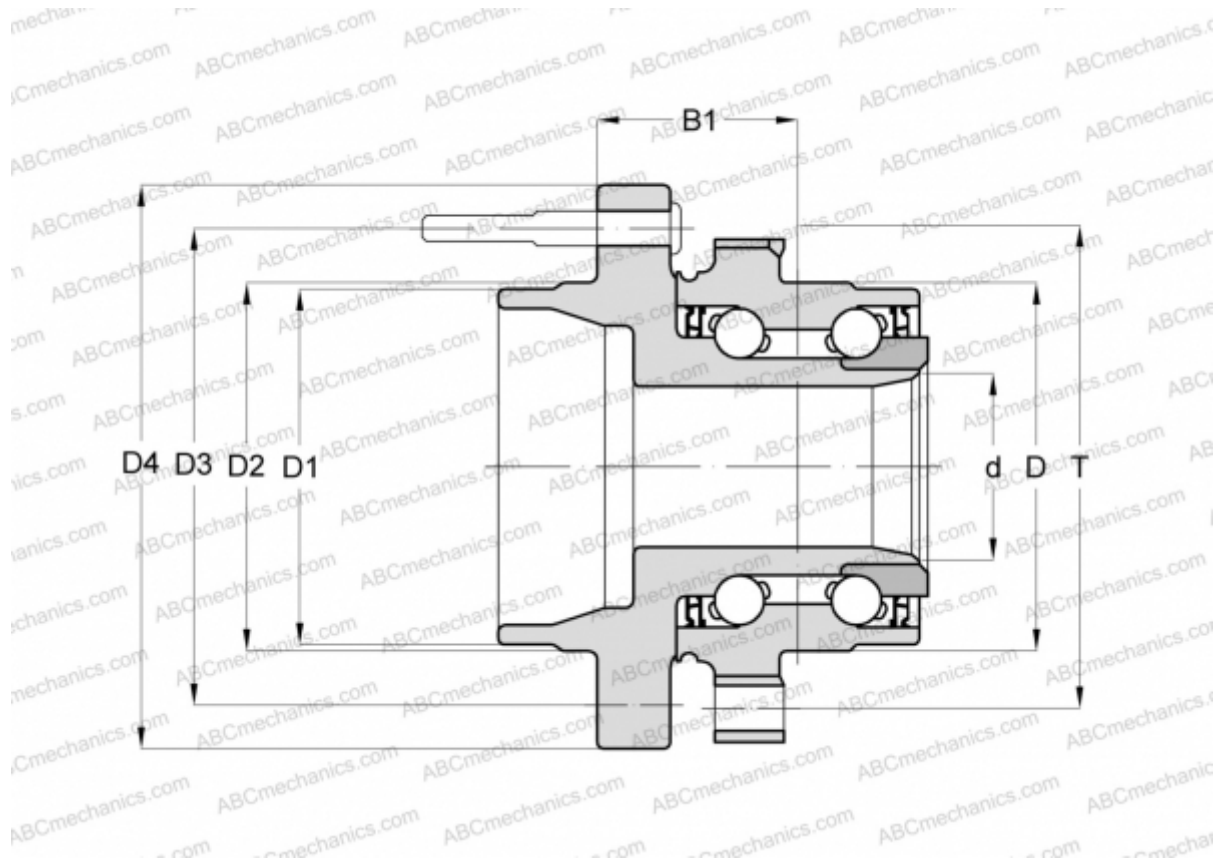

### Technical specification

#### DIMENSIONS, MM

D	92,000
D1	70,140
D2	70,630
D3	120,650
D4	144,500
B1	47,300
T	120,650

#### MANUFACTURER

[FAG](#)