

## 102055 FAG

Angular contact ball bearings

TYPE: Ball bearings, Angular contact ball bearing, Double row, Hub bearing (unit), FAG production, generation 3

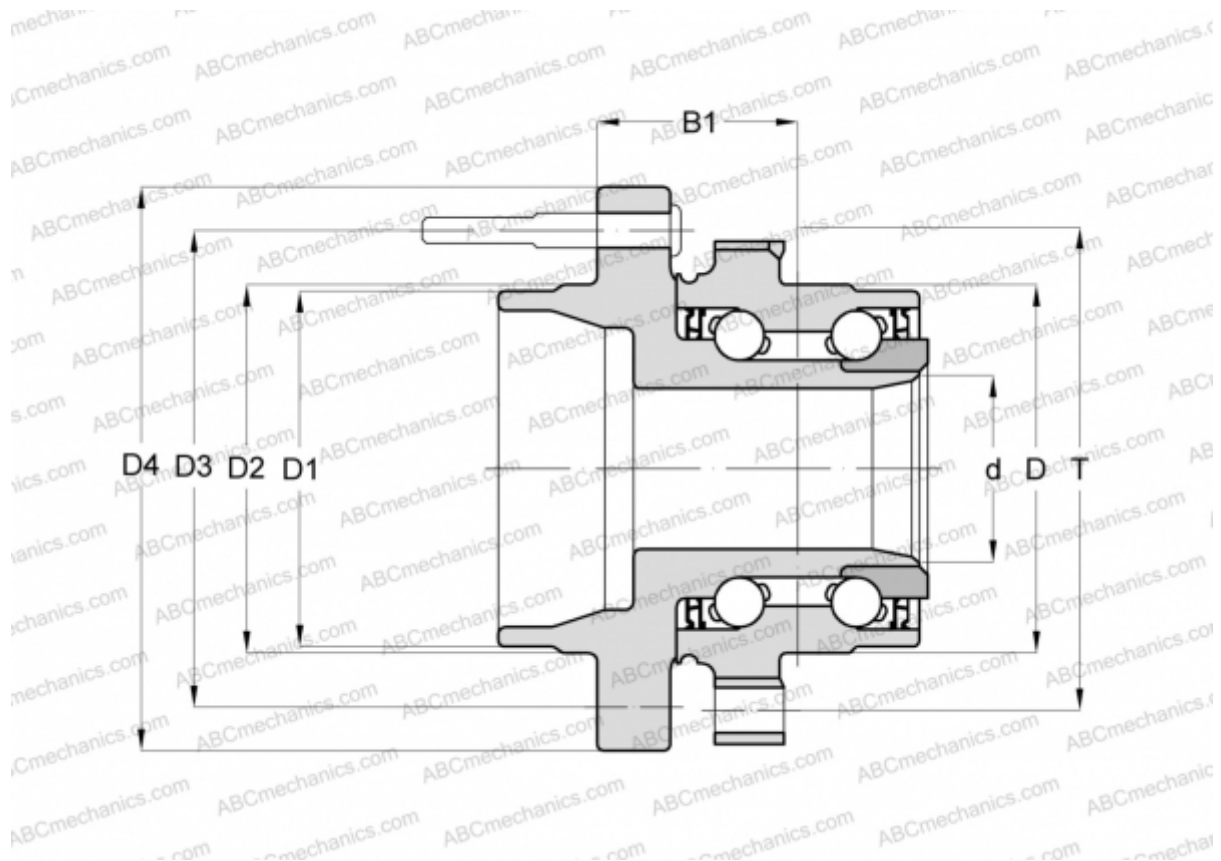

### Technical specification

#### DIMENSIONS, MM

D	87,000
D1	56,900
D2	60,900
D3	100,000
D4	126,000
B1	37,500
T	112,000

#### MANUFACTURER

[FAG](#)