

102059 FAG

Angular contact ball bearings

TYPE: Ball bearings, Angular contact ball bearing, Double row, Hub bearing (unit), FAG production, generation 3

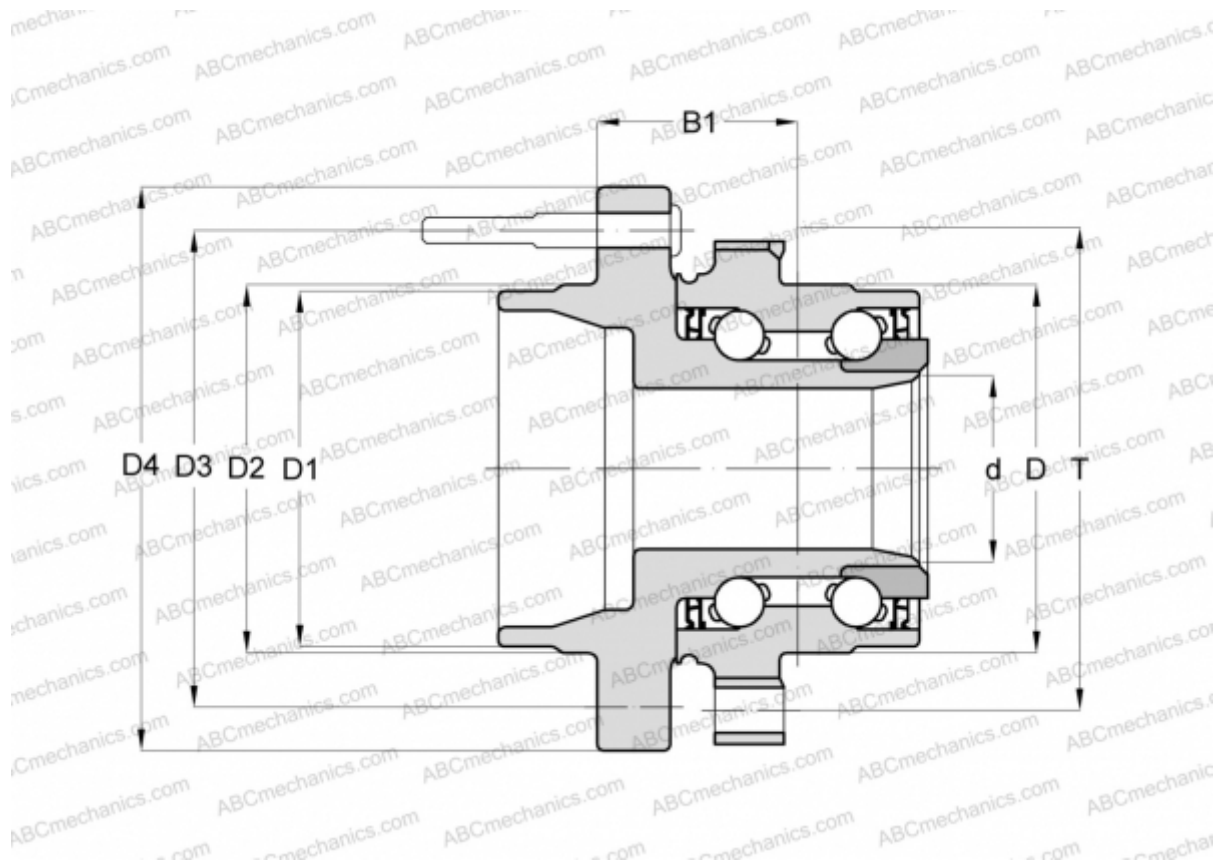

Technical specification

DIMENSIONS, MM

D	90,000
D1	70,140
D2	70,630
D3	115,000
D4	146,000
B1	42,000
T	116,000

MANUFACTURER

[FAG](#)