

102066 FAG

Angular contact ball bearings

TYPE: Ball bearings, Angular contact ball bearing, Double row, Hub bearing (unit), FAG production, generation 3

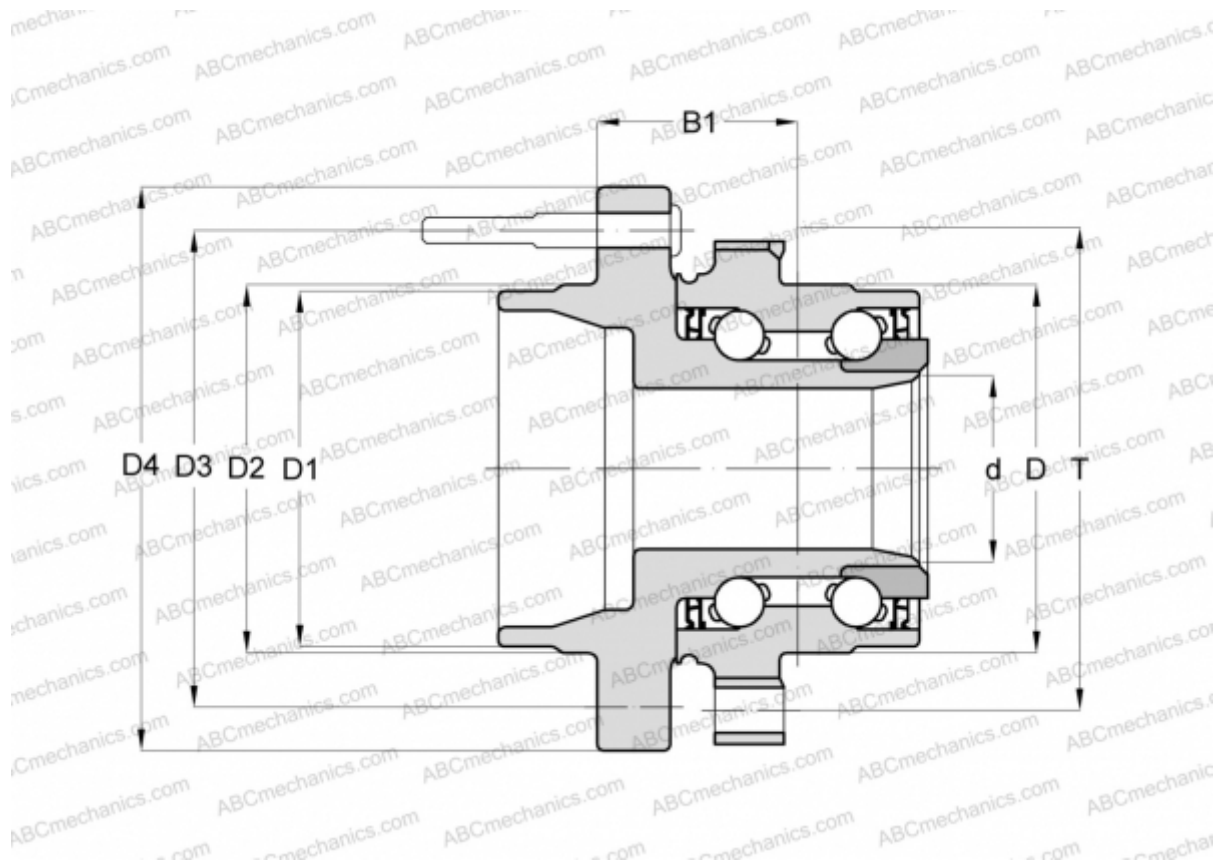

Technical specification

DIMENSIONS, MM

D	89,000
D1	66,000
D2	68,000
D3	114,300
D4	148,000
B1	69,000
T	114,000

MANUFACTURER

[FAG](#)