

## 102067 FAG

Angular contact ball bearings

TYPE: Ball bearings, Angular contact ball bearing, Double row, Hub bearing (unit), FAG production, generation 3

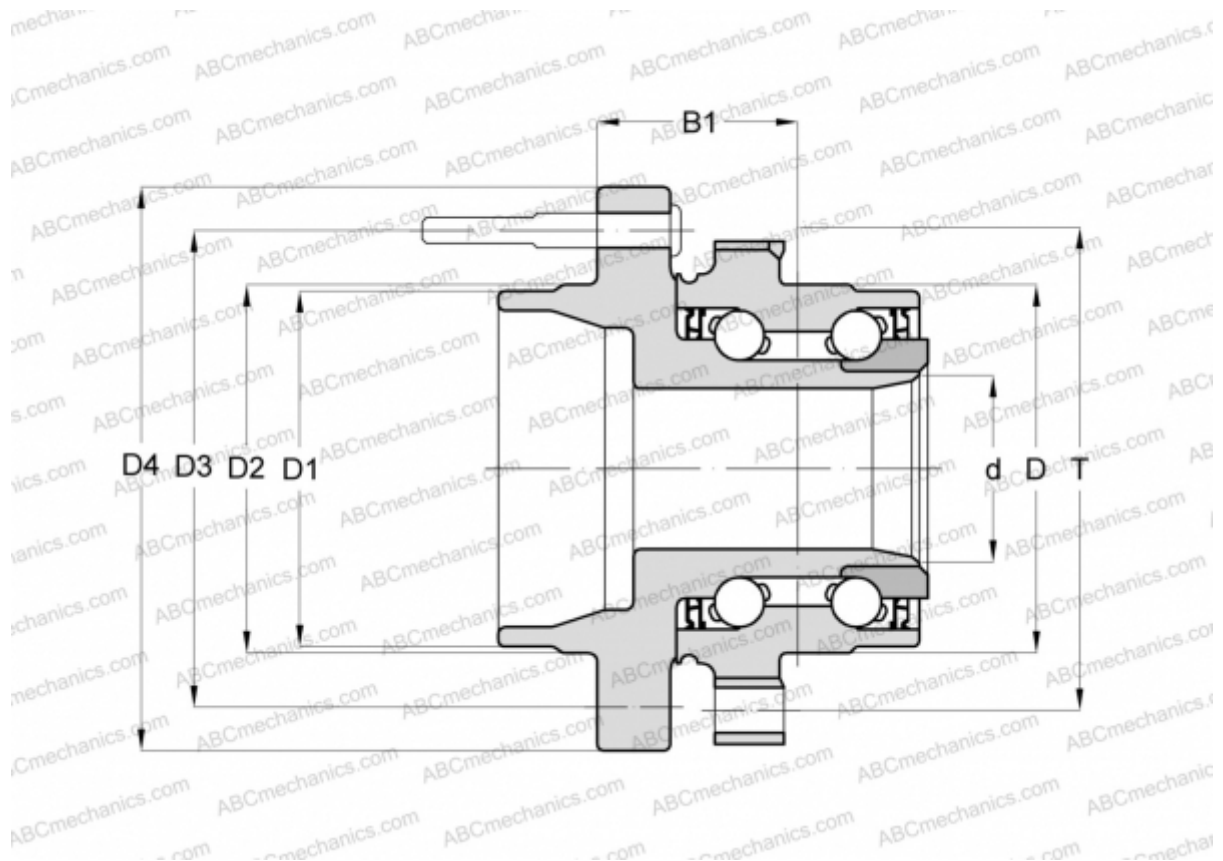

### Technical specification

#### DIMENSIONS, MM

D	89,000
D1	77,700
D2	82,000
D3	139,700
D4	171,500
B1	56,300
T	114,000

#### MANUFACTURER

[FAG](#)