

102076 FAG

Angular contact ball bearings

TYPE: Ball bearings, Angular contact ball bearing, Double row, Hub bearing (unit), FAG production, generation 3

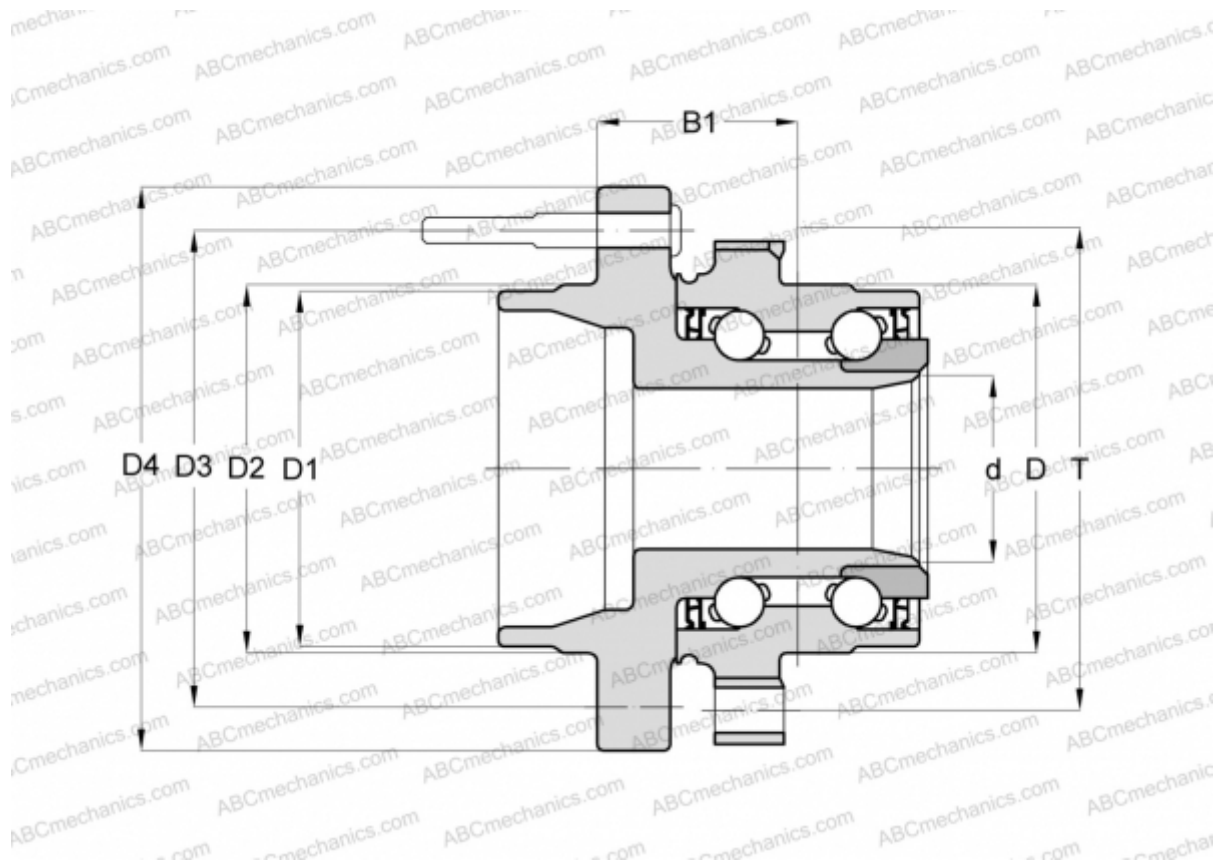

Technical specification

DIMENSIONS, MM

D	66,000
D1	67,000
D2	90,000
D3	114,300
D4	137,500
B1	59,000
T	90,000

MANUFACTURER

[FAG](#)