

## 102081 FAG

Angular contact ball bearings

TYPE: Ball bearings, Angular contact ball bearing, Double row, Hub bearing (unit), FAG production, generation 3

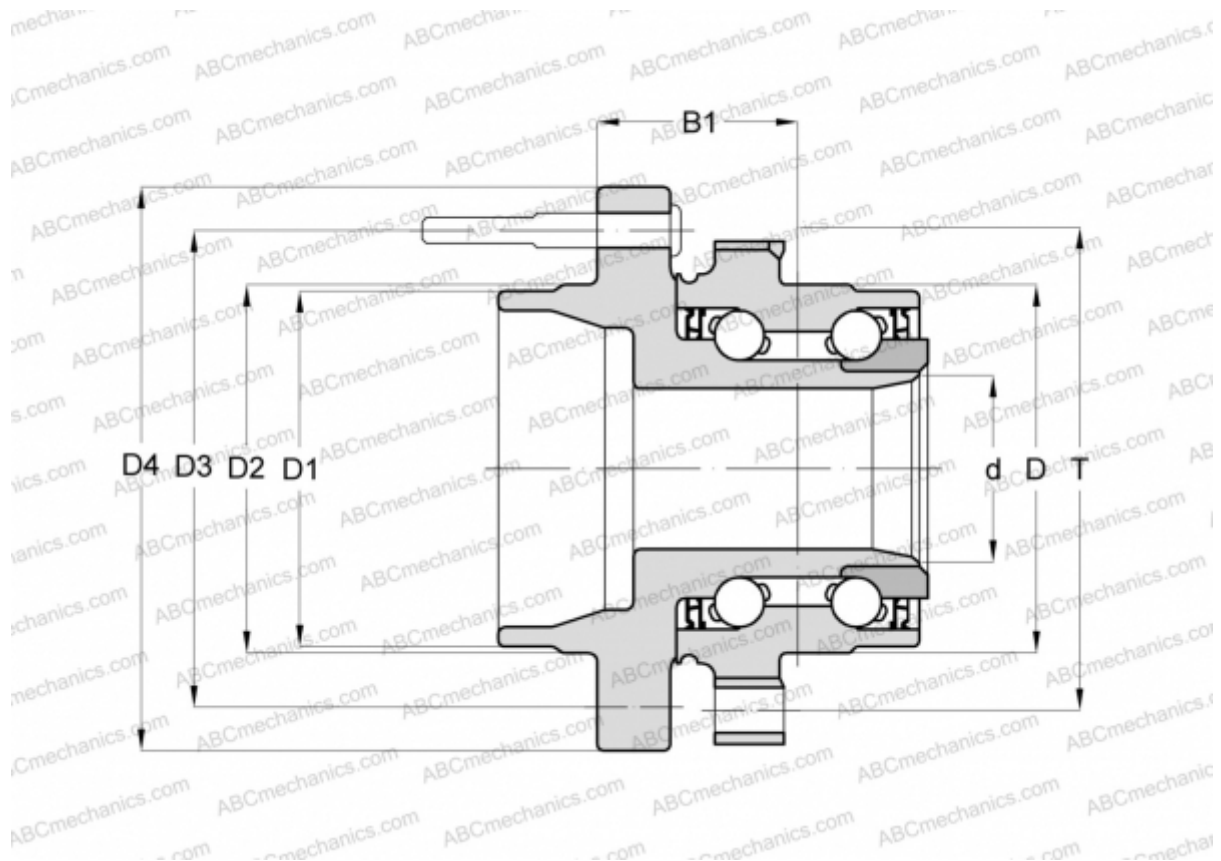

### Technical specification

#### DIMENSIONS, MM

D	86,000
D1	56,800
D2	57,300
D3	100,000
D4	126,500
B1	48,000
T	108,000

#### MANUFACTURER

[FAG](#)