

## 102097 FAG

Angular contact ball bearings

TYPE: Ball bearings, Angular contact ball bearing, Double row, Hub bearing (unit), FAG production, generation 3

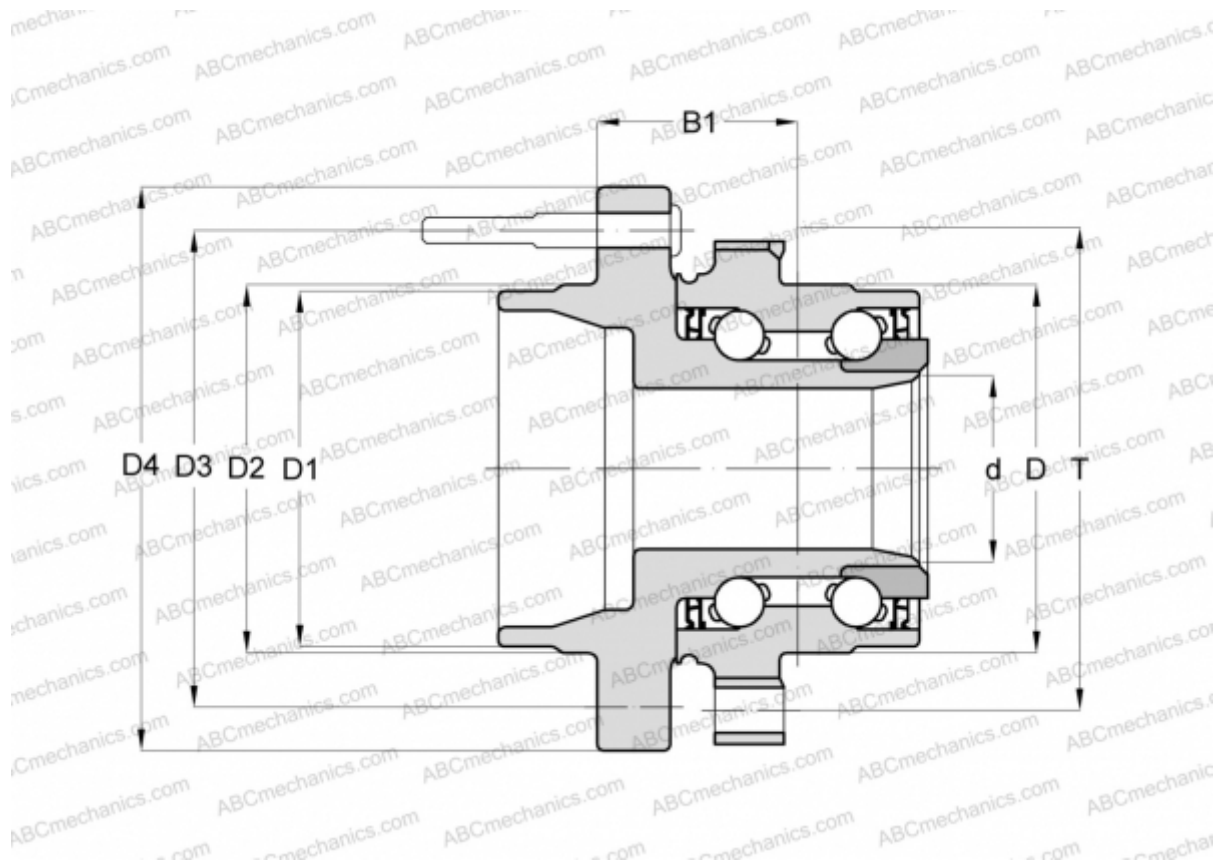

### Technical specification

#### DIMENSIONS, MM

D	73,900
D1	60,000
D2	62,000
D3	114,300
D4	152,000
B1	74,500
T	99,000

#### MANUFACTURER

[FAG](#)