

## 102101 FAG

Angular contact ball bearings

TYPE: Ball bearings, Angular contact ball bearing, Double row, Hub bearing (unit), FAG production, generation 3

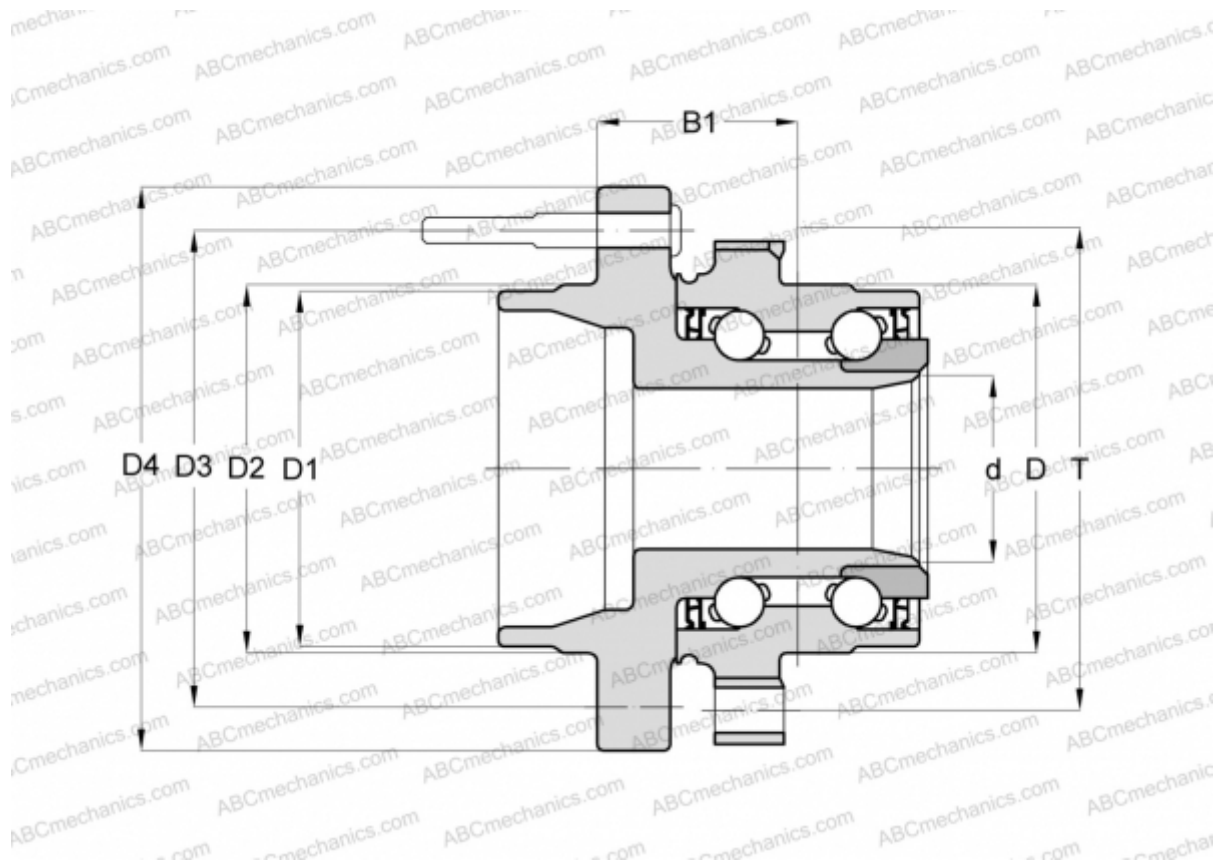

### Technical specification

#### DIMENSIONS, MM

D	78,900
D1	70,100
D2	70,600
D3	115,000
D4	150,000
B1	65,000
T	100,600

#### MANUFACTURER

[FAG](#)