

102115 FAG

Angular contact ball bearings

TYPE: Ball bearings, Angular contact ball bearing, Double row, Hub bearing (unit), FAG production, generation 3

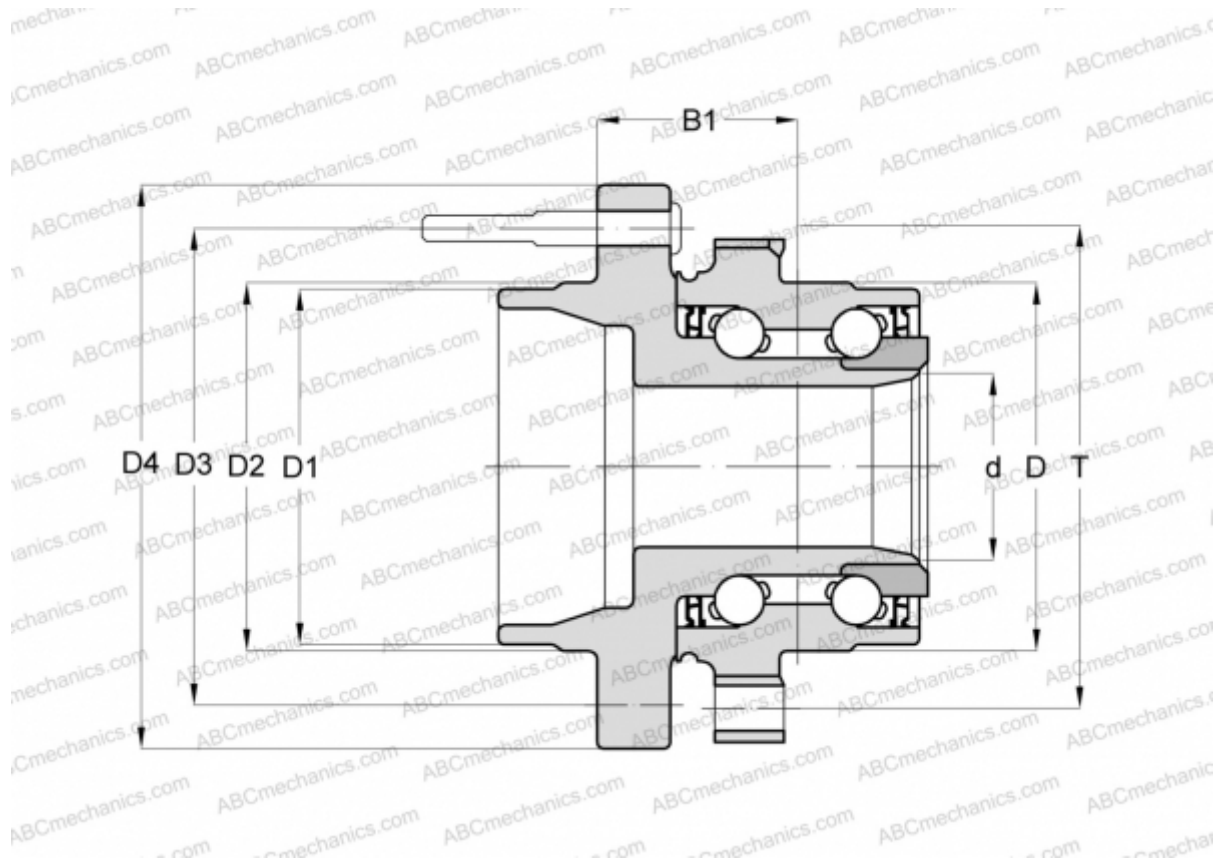

Technical specification

DIMENSIONS, MM

D	85,000
D1	71,400
D2	81,900
D3	127,000
D4	167,400
B1	48,600
T	110,000

MANUFACTURER

[FAG](#)