

102123 FAG

Angular contact ball bearings

TYPE: Ball bearings, Angular contact ball bearing, Double row, Hub bearing (unit), FAG production, generation 3

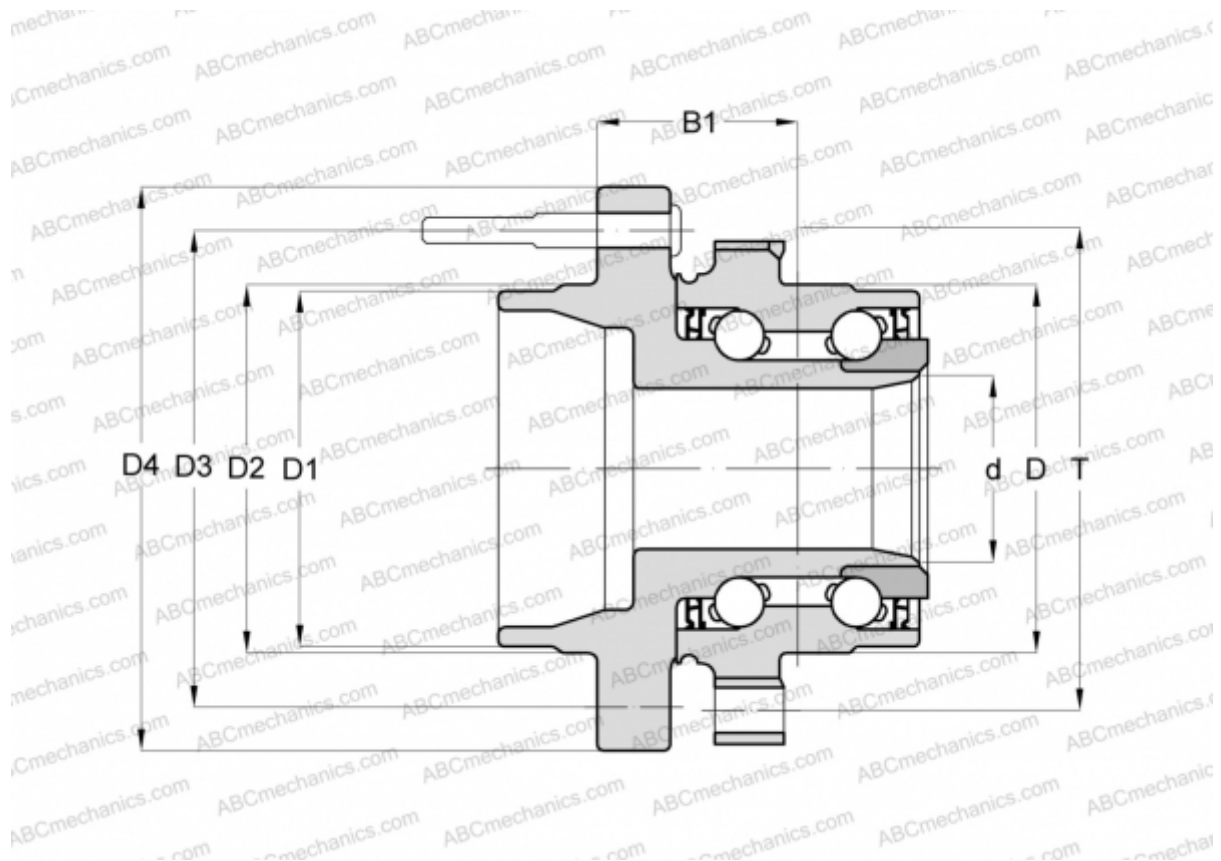

Technical specification

DIMENSIONS, MM

D	85,000
D1	71,430
D2	71,930
D3	127,000
D4	165,000
B1	63,500
T	119,500

MANUFACTURER

[FAG](#)