

## 102130 FAG

Angular contact ball bearings

TYPE: Ball bearings, Angular contact ball bearing, Double row, Hub bearing (unit), FAG production, generation 3

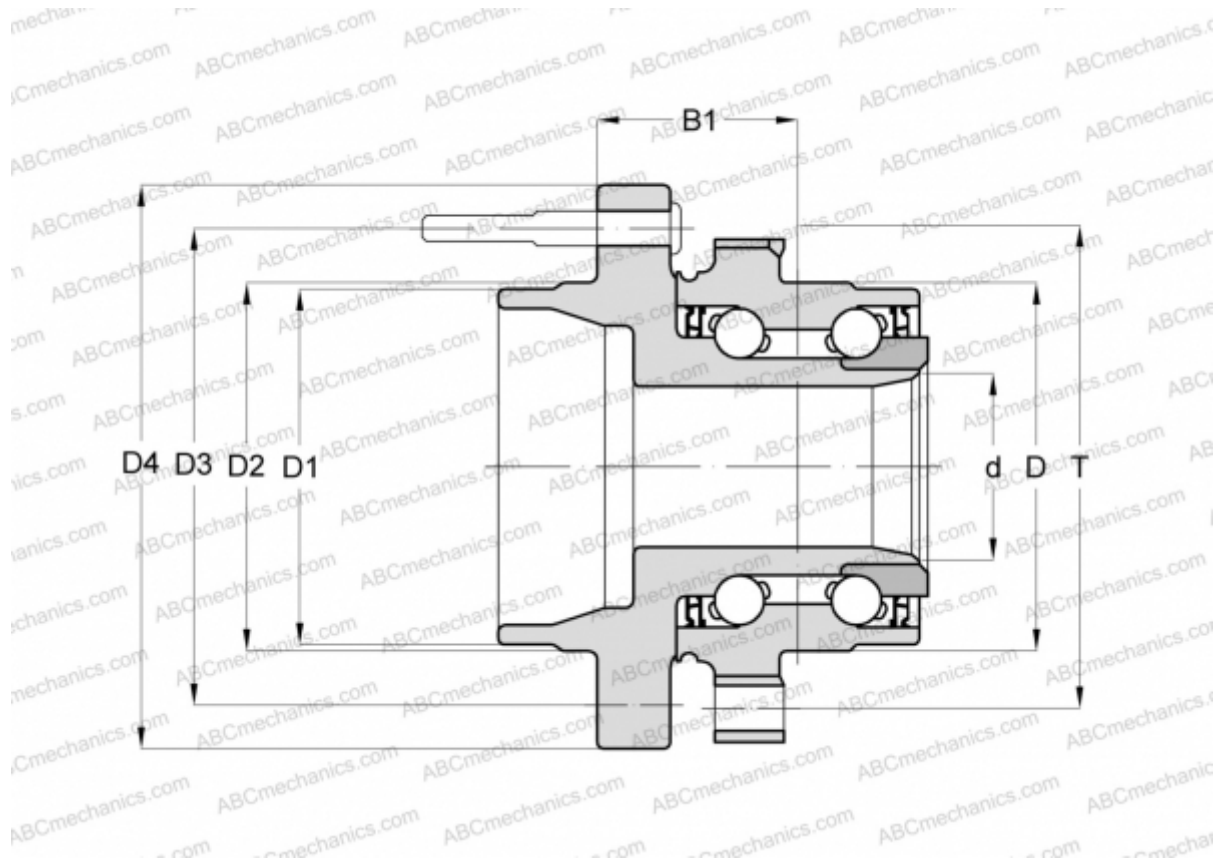

### Technical specification

#### DIMENSIONS, MM

D	81,900
D1	48,000
D2	64,000
D3	114,300
D4	151,800
B1	61,400
T	104,600

#### MANUFACTURER

[FAG](#)