

102134 FAG

Angular contact ball bearings

TYPE: Ball bearings, Angular contact ball bearing, Double row, Hub bearing (unit), FAG production, generation 3

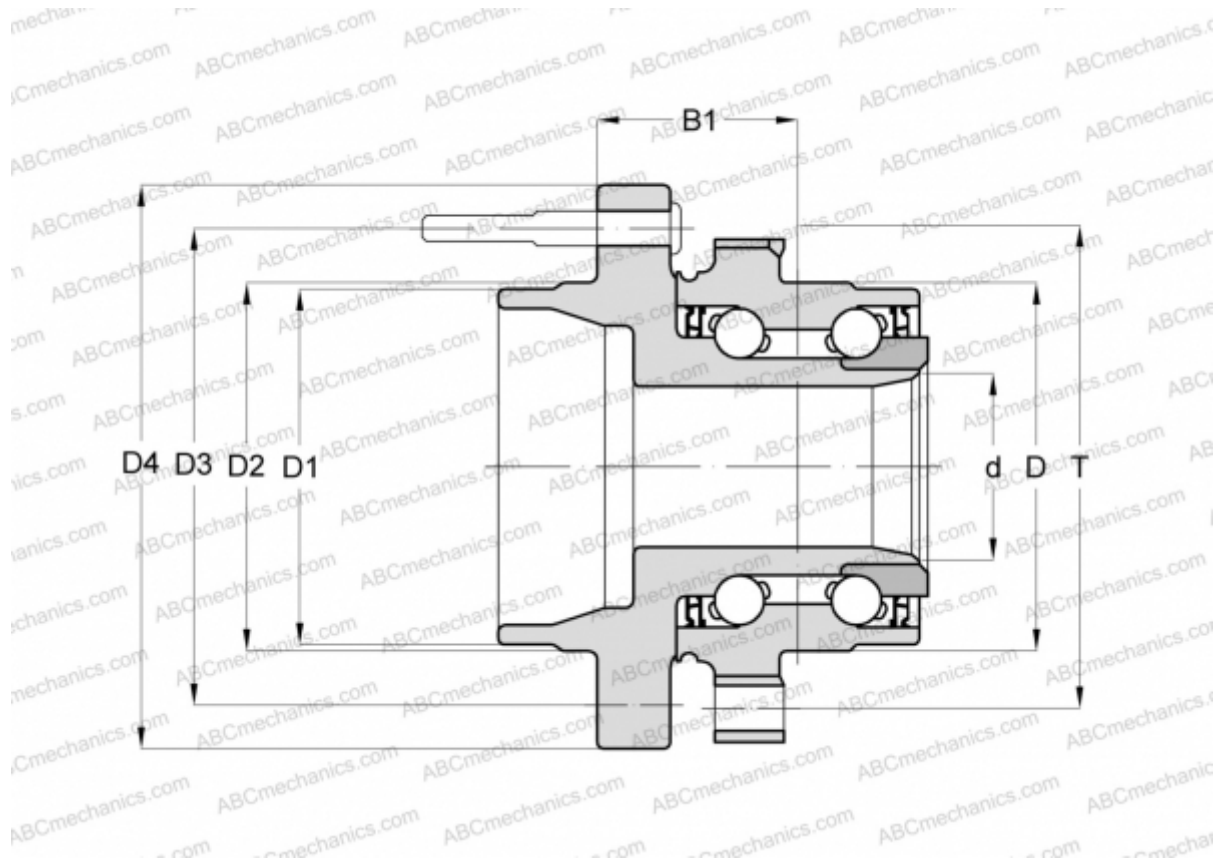

Technical specification

DIMENSIONS, MM

D	71,800
D1	70,100
D2	70,600
D3	115,000
D4	151,000
B1	65,100
T	100,650

MANUFACTURER

[FAG](#)