

102136 FAG

Angular contact ball bearings

TYPE: Ball bearings, Angular contact ball bearing, Double row, Hub bearing (unit), FAG production, generation 3

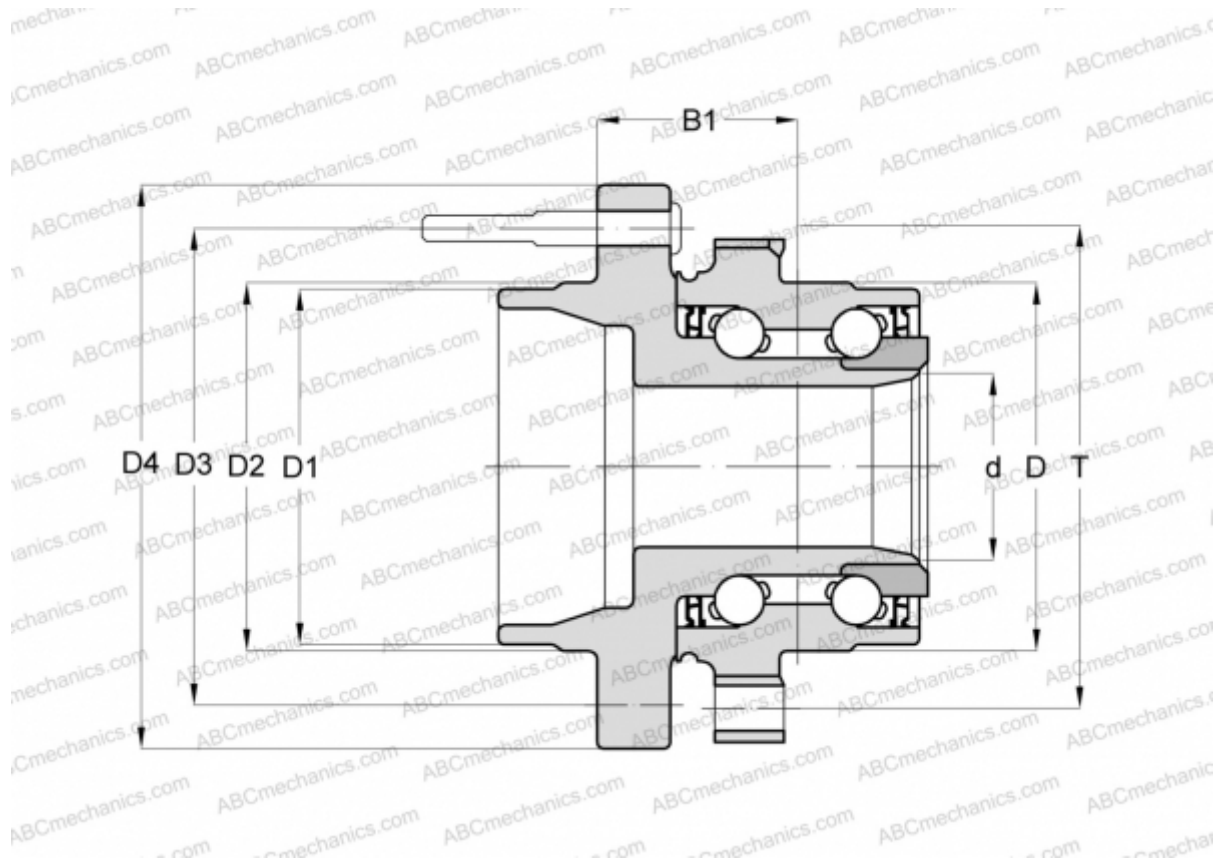

Technical specification

DIMENSIONS, MM

D	61,000
D1	57,000
D2	57,500
D3	100,000
D4	138,000
B1	65,000
T	88,000

MANUFACTURER

[FAG](#)