

## 102152 FAG

Angular contact ball bearings

TYPE: Ball bearings, Angular contact ball bearing, Double row, Hub bearing (unit), FAG production, generation 3

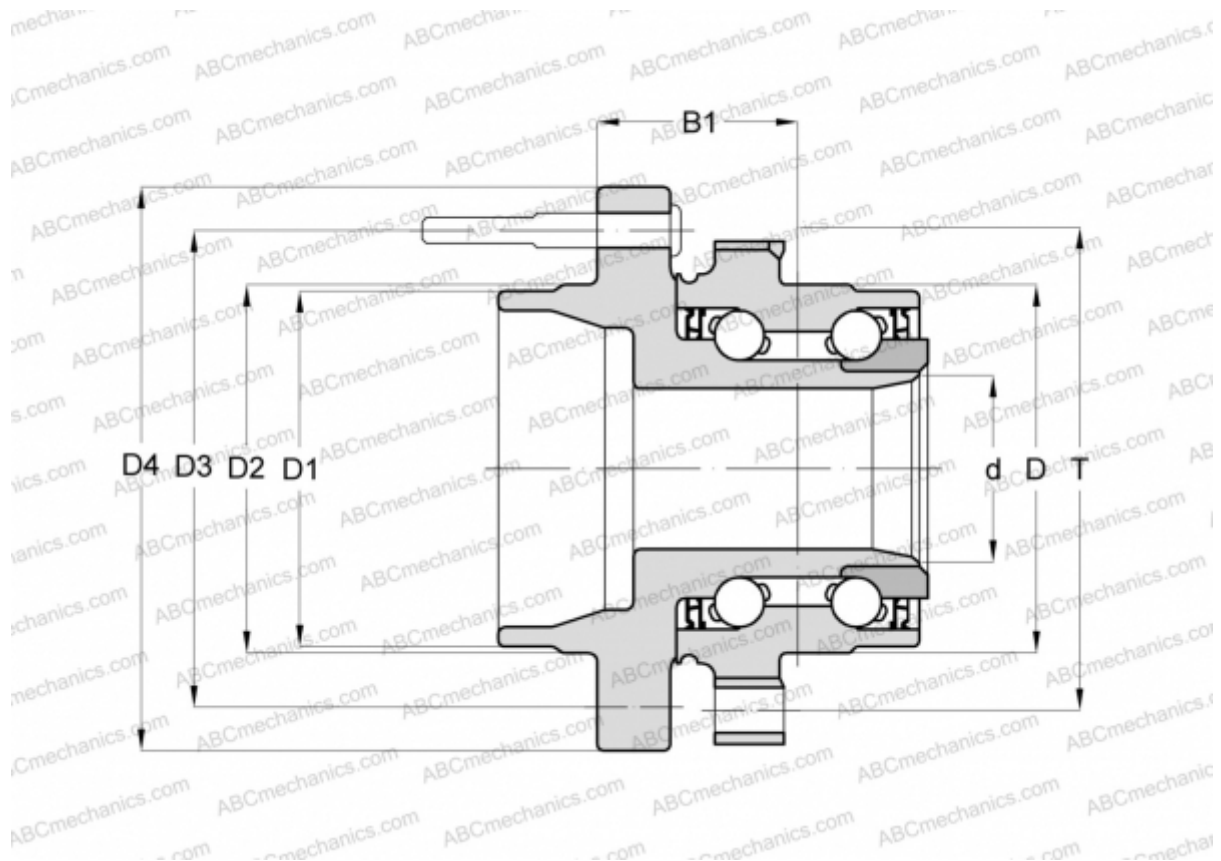

### Technical specification

#### DIMENSIONS, MM

D	113,830
D1	121,000
D2	122,000
D3	164,780
D4	205,000
B1	54,850
T	140,490

#### MANUFACTURER

[FAG](#)