

## 102160 FAG

Angular contact ball bearings

TYPE: Ball bearings, Angular contact ball bearing, Double row, Hub bearing (unit), FAG production, generation 3

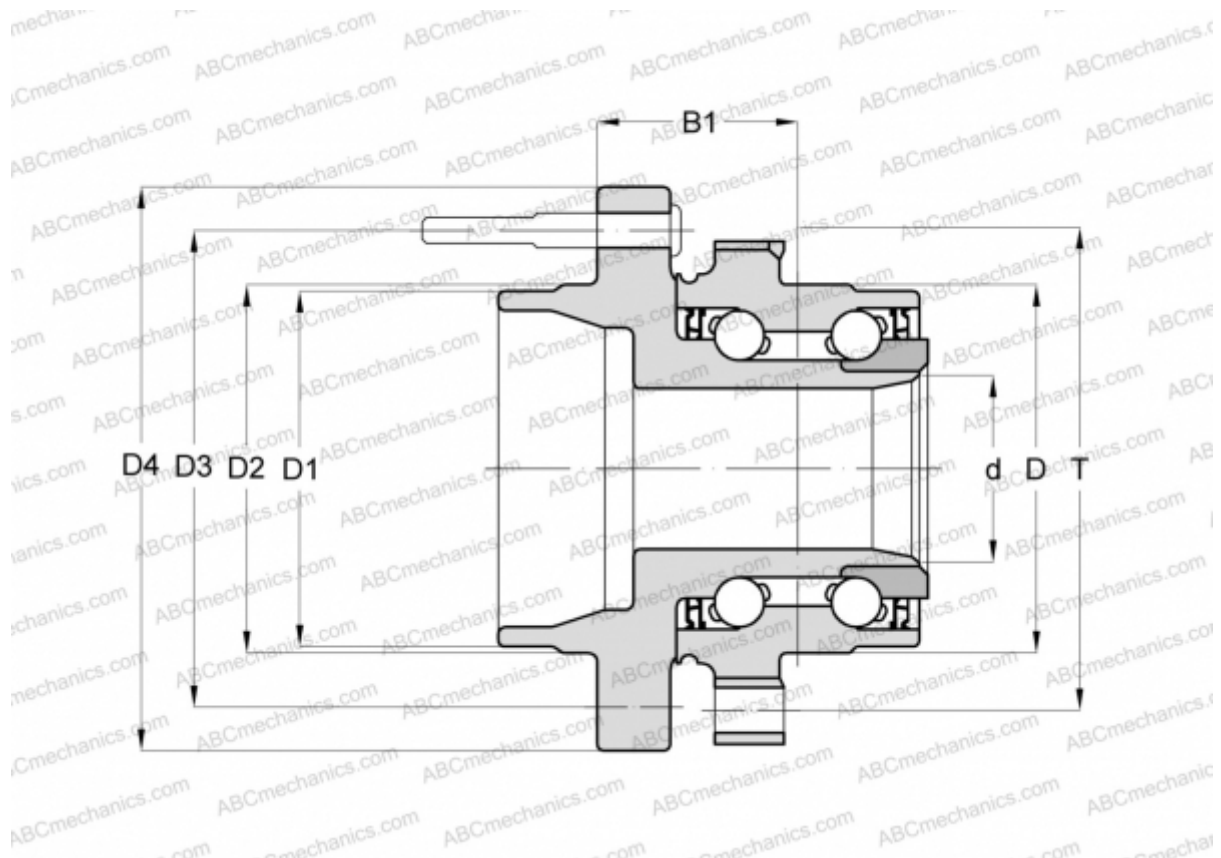

### Technical specification

#### DIMENSIONS, MM

D	85,020
D1	99,520
D2	100,080
D3	139,700
D4	184,160
B1	67,400
T	112,730

#### MANUFACTURER

[FAG](#)