

102168 FAG

Angular contact ball bearings

TYPE: Ball bearings, Angular contact ball bearing, Double row, Hub bearing (unit), FAG production, generation 3

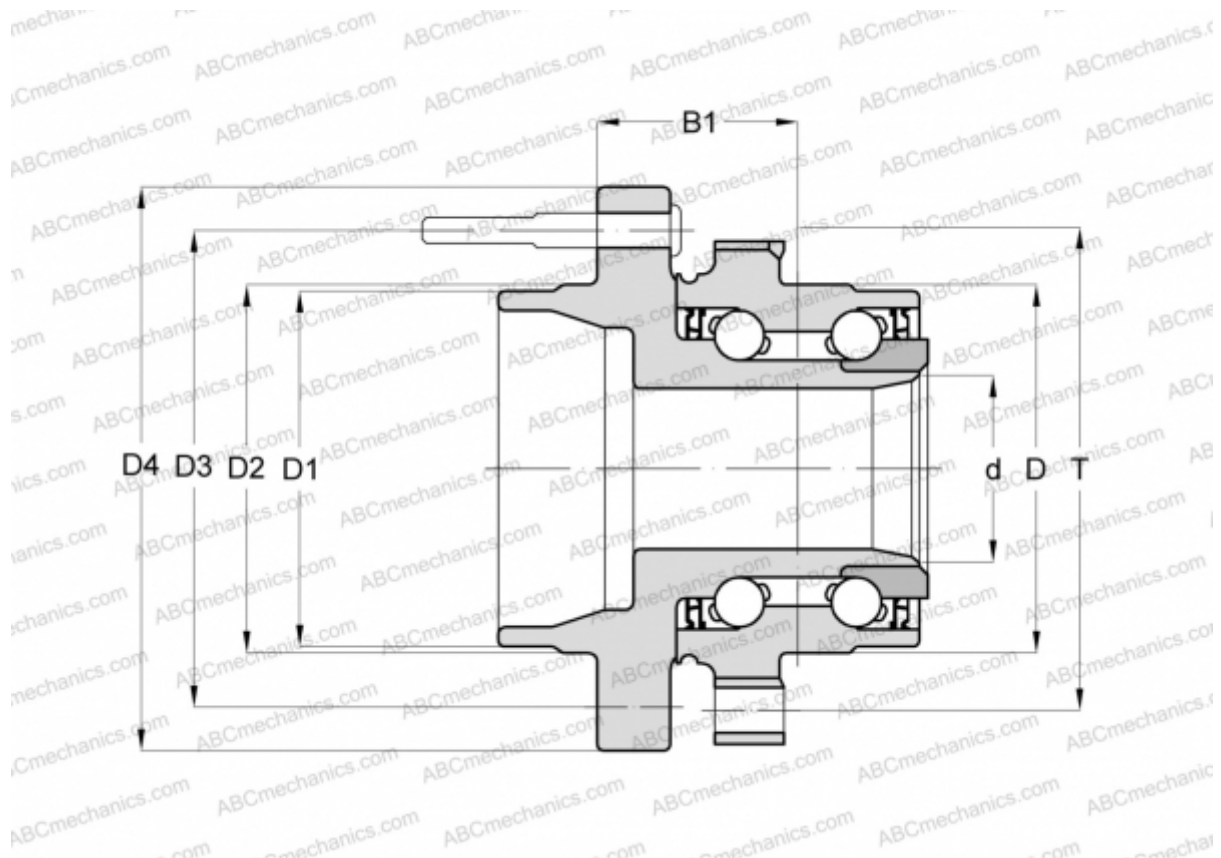

Technical specification

DIMENSIONS, MM

D	84,988
D1	99,520
D2	100,000
D3	140,005
D4	184,150
B1	67,208
T	111,989

MANUFACTURER

[FAG](#)