

102173 FAG

Angular contact ball bearings

TYPE: Ball bearings, Angular contact ball bearing, Double row, Hub bearing (unit), FAG production, generation 3

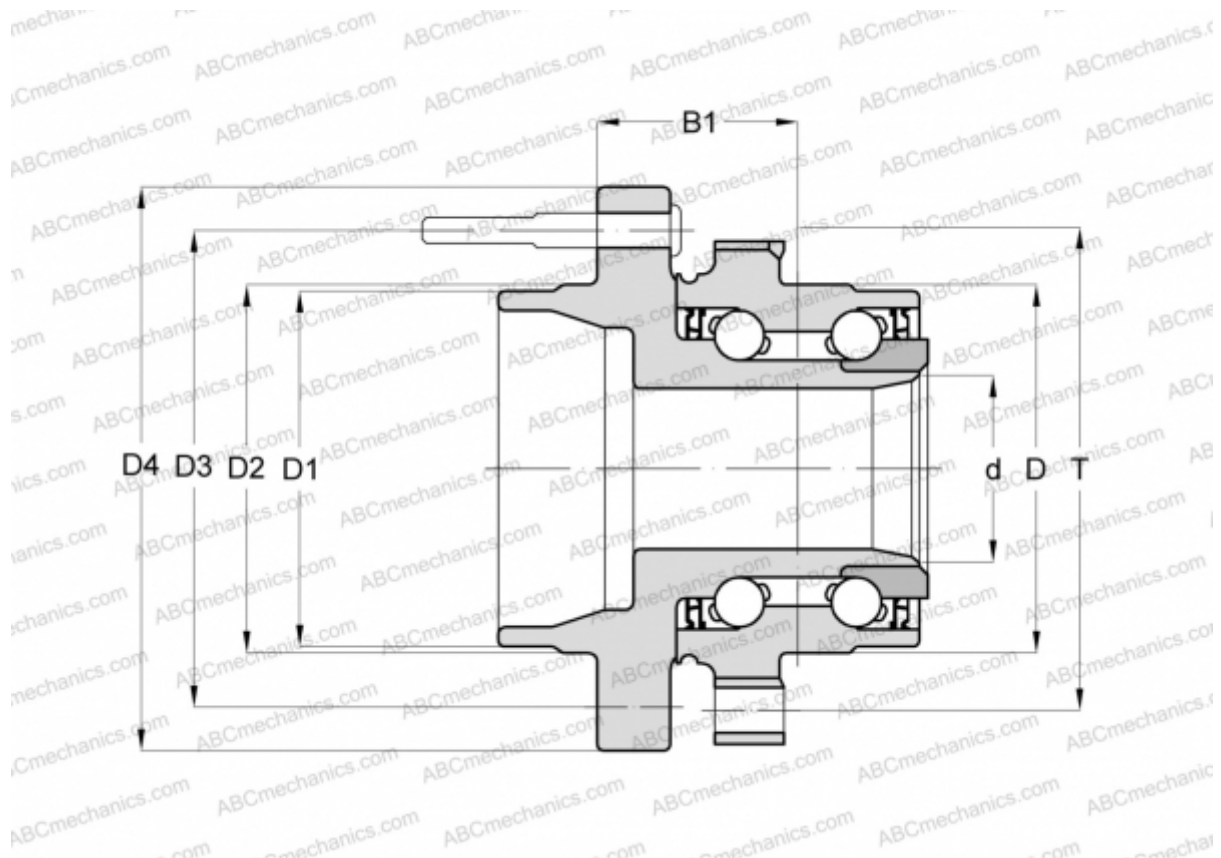

Technical specification

DIMENSIONS, MM

D	100,000
D1	70,450
D2	71,850
D3	114,300
D4	149,400
B1	56,100
T	120,600

MANUFACTURER

[FAG](#)