

102183 FAG

Angular contact ball bearings

TYPE: Ball bearings, Angular contact ball bearing, Double row, Hub bearing (unit), FAG production, generation 3

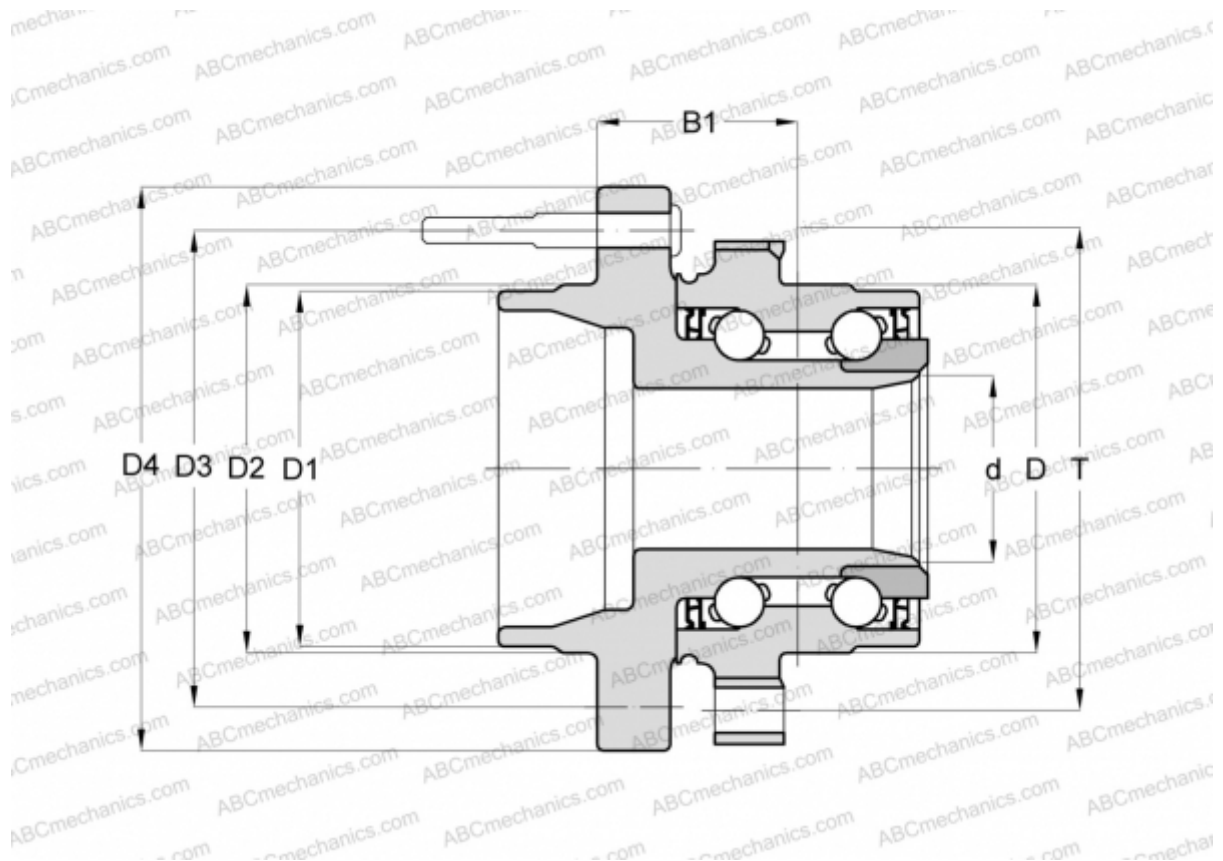

Technical specification

DIMENSIONS, MM

D	99,000
D1	86,800
D2	90,000
D3	134,000
D4	183,000
B1	45,500
T	160,500

MANUFACTURER

[FAG](#)