

102222 FAG

Angular contact ball bearings

TYPE: Ball bearings, Angular contact ball bearing, Double row, Hub bearing (unit), FAG production, generation 3

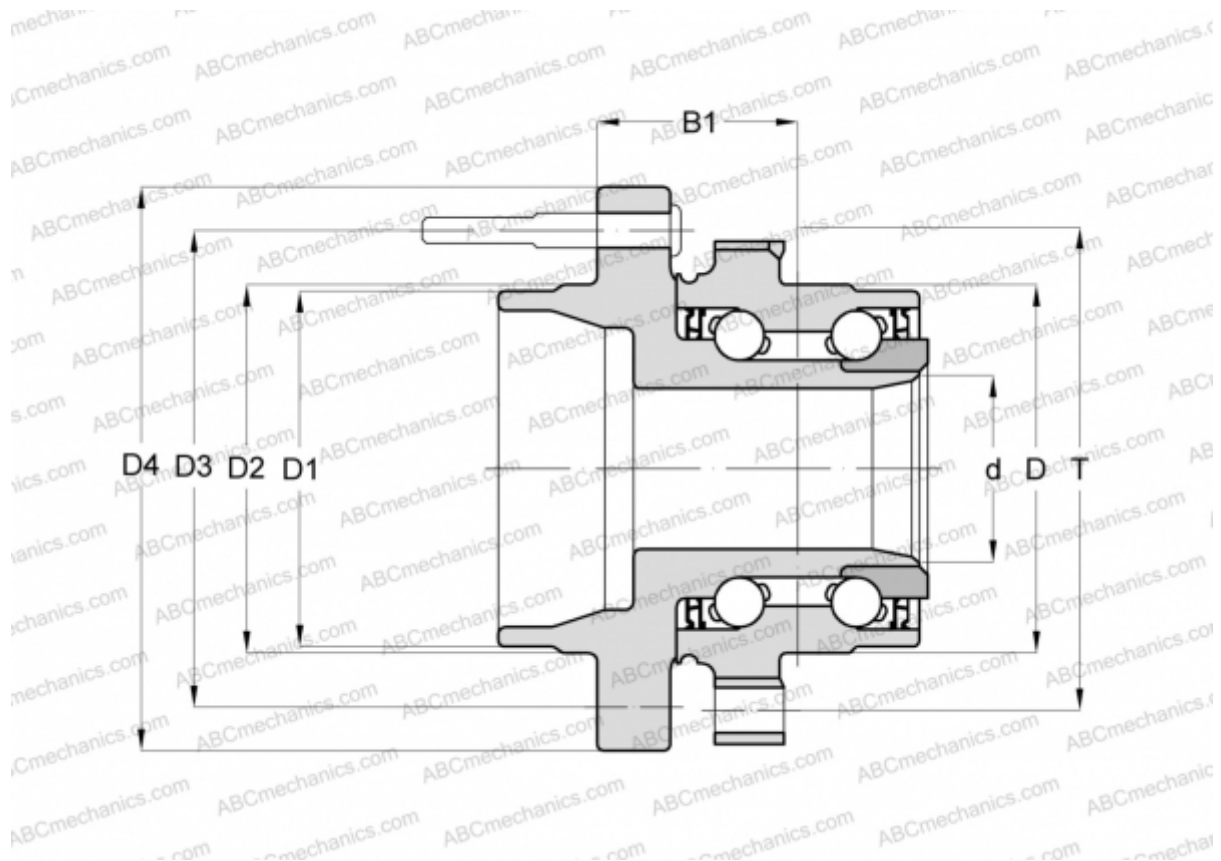

Technical specification

DIMENSIONS, MM

D	92,000
D1	71,400
D2	71,900
D3	114,300
D4	154,000
B1	48,500
T	120,700

MANUFACTURER

[FAG](#)