

102226 FAG

Angular contact ball bearings

TYPE: Ball bearings, Angular contact ball bearing, Double row, Hub bearing (unit), FAG production, generation 3

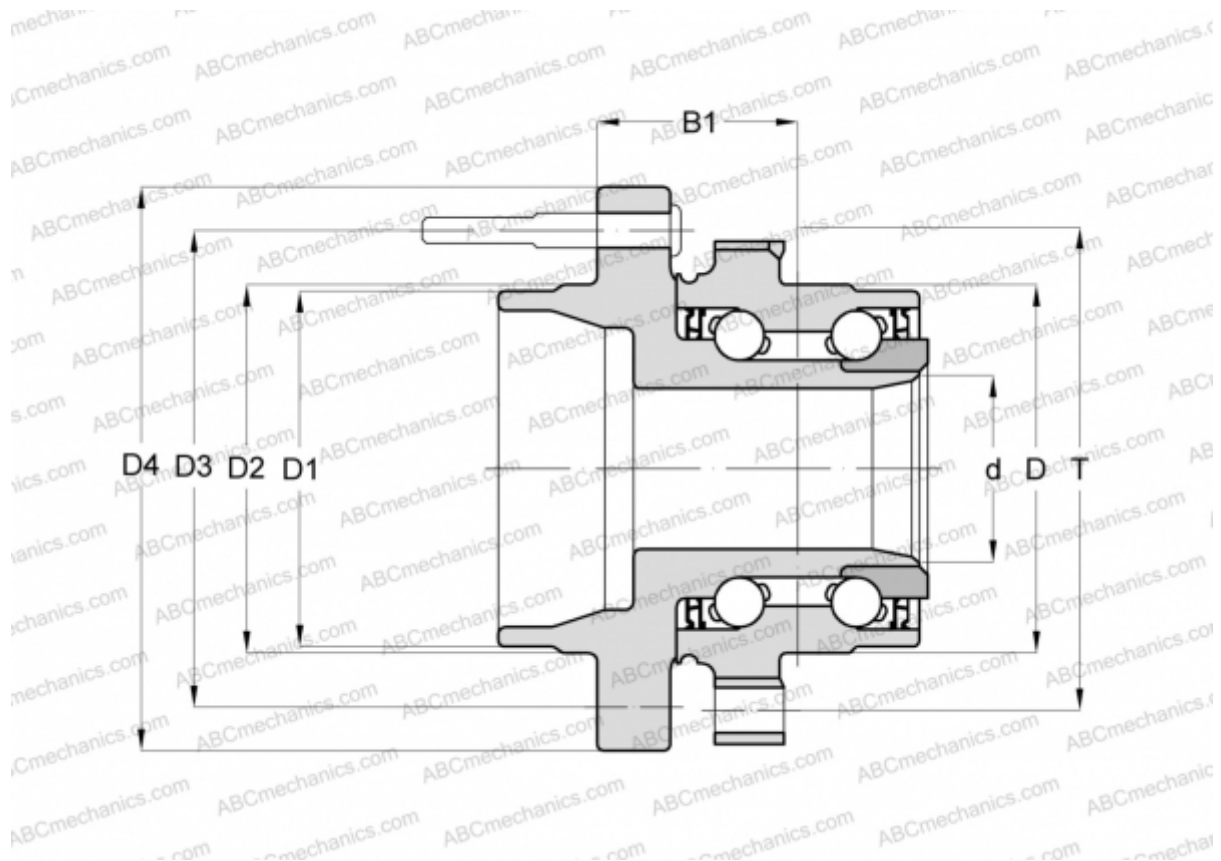

Technical specification

DIMENSIONS, MM

D	95,000
D1	74,000
D2	75,550
D3	132,000
D4	168,830
B1	47,150
T	120,820

MANUFACTURER

[FAG](#)