

102238 FAG

Angular contact ball bearings

TYPE: Ball bearings, Angular contact ball bearing, Double row, Hub bearing (unit), FAG production, generation 3

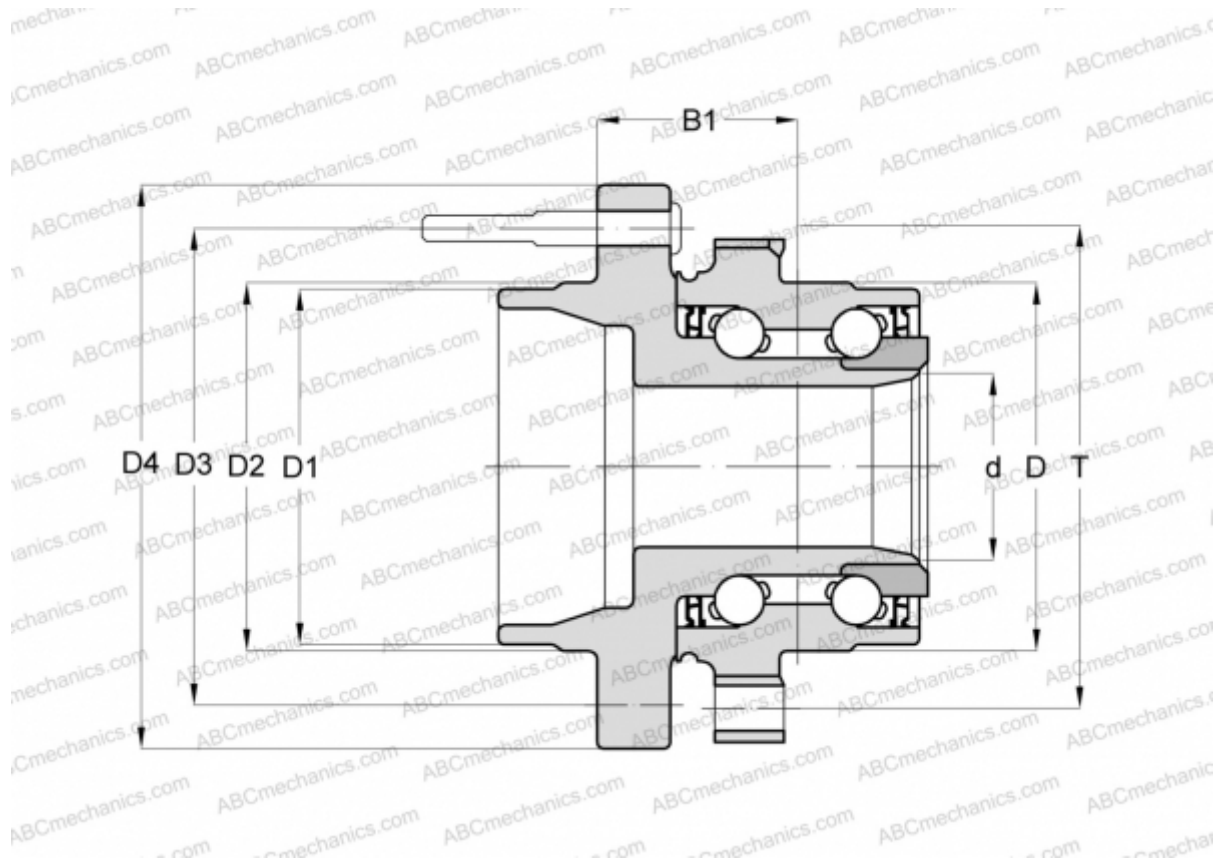

Technical specification

DIMENSIONS, MM

D	114,000
D1	124,000
D2	127,000
D3	180,000
D4	221,000
B1	74,000
T	148,000

MANUFACTURER

[FAG](#)