

102269 FAG

Angular contact ball bearings

TYPE: Ball bearings, Angular contact ball bearing, Double row, Hub bearing (unit), FAG production, generation 3

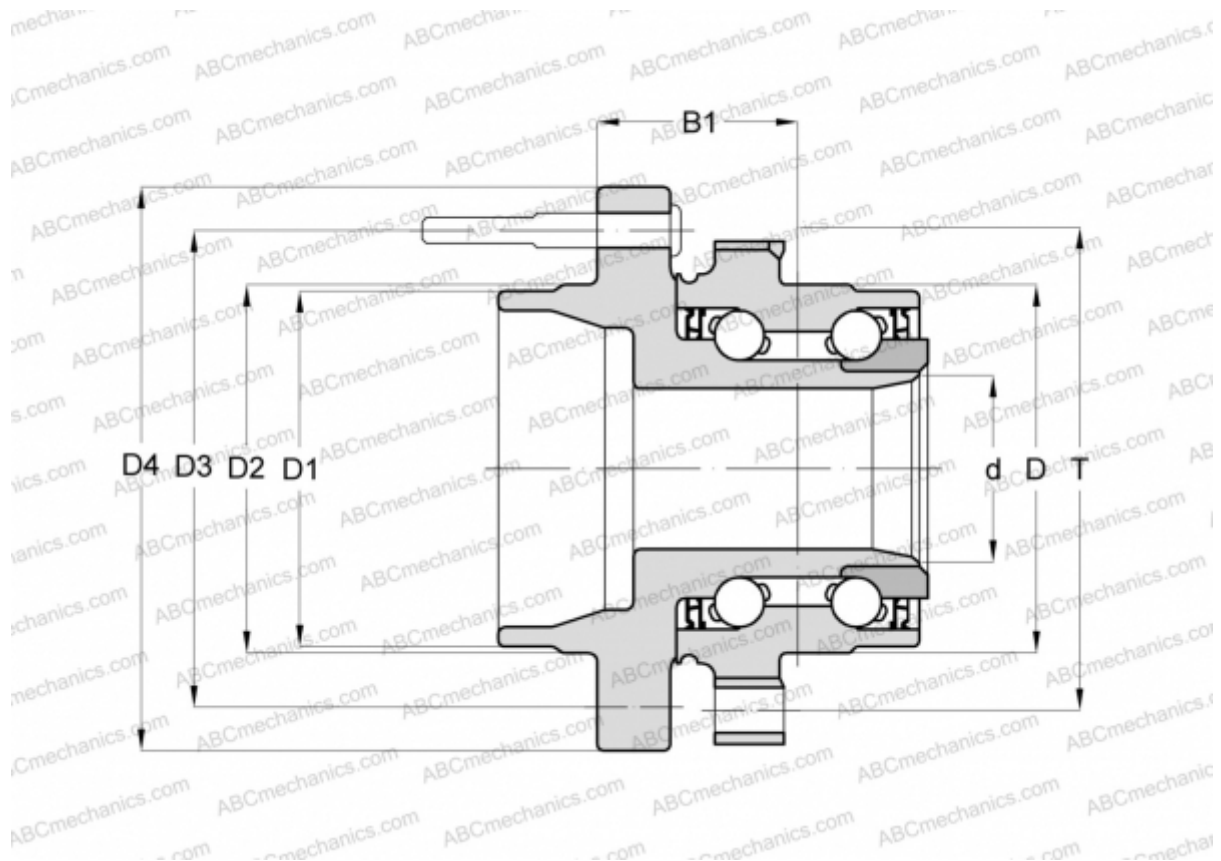

Technical specification

DIMENSIONS, MM

D	74,000
D1	63,260
D2	64,620
D3	114,300
D4	156,200
B1	61,130
T	107,580

MANUFACTURER

[FAG](#)