

## 102274 FAG

Angular contact ball bearings

TYPE: Ball bearings, Angular contact ball bearing, Double row, Hub bearing (unit), FAG production, generation 3

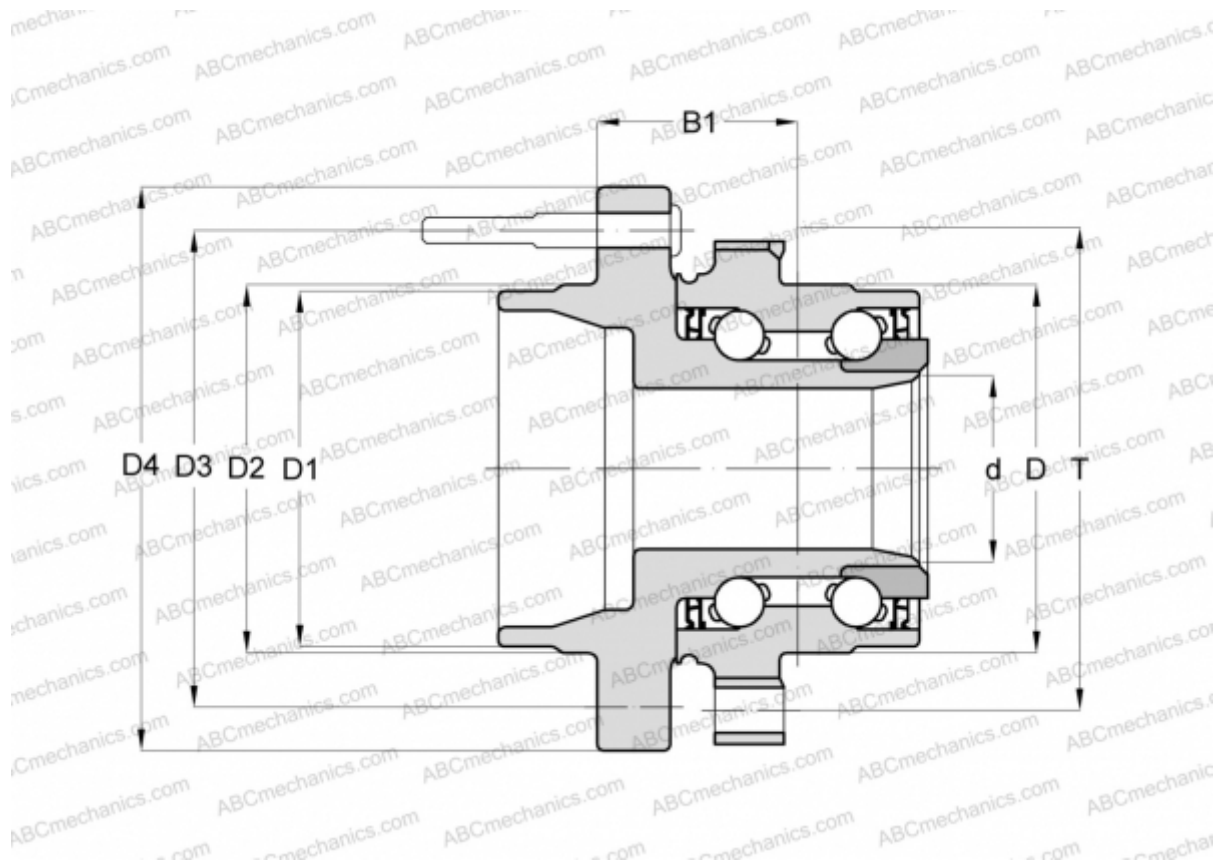

### Technical specification

#### DIMENSIONS, MM

D	78,000
D1	70,500
D2	72,000
D3	114,300
D4	139,600
B1	63,000
T	106,000

#### MANUFACTURER

[FAG](#)