

102275 FAG

Angular contact ball bearings

TYPE: Ball bearings, Angular contact ball bearing, Double row, Hub bearing (unit), FAG production, generation 3

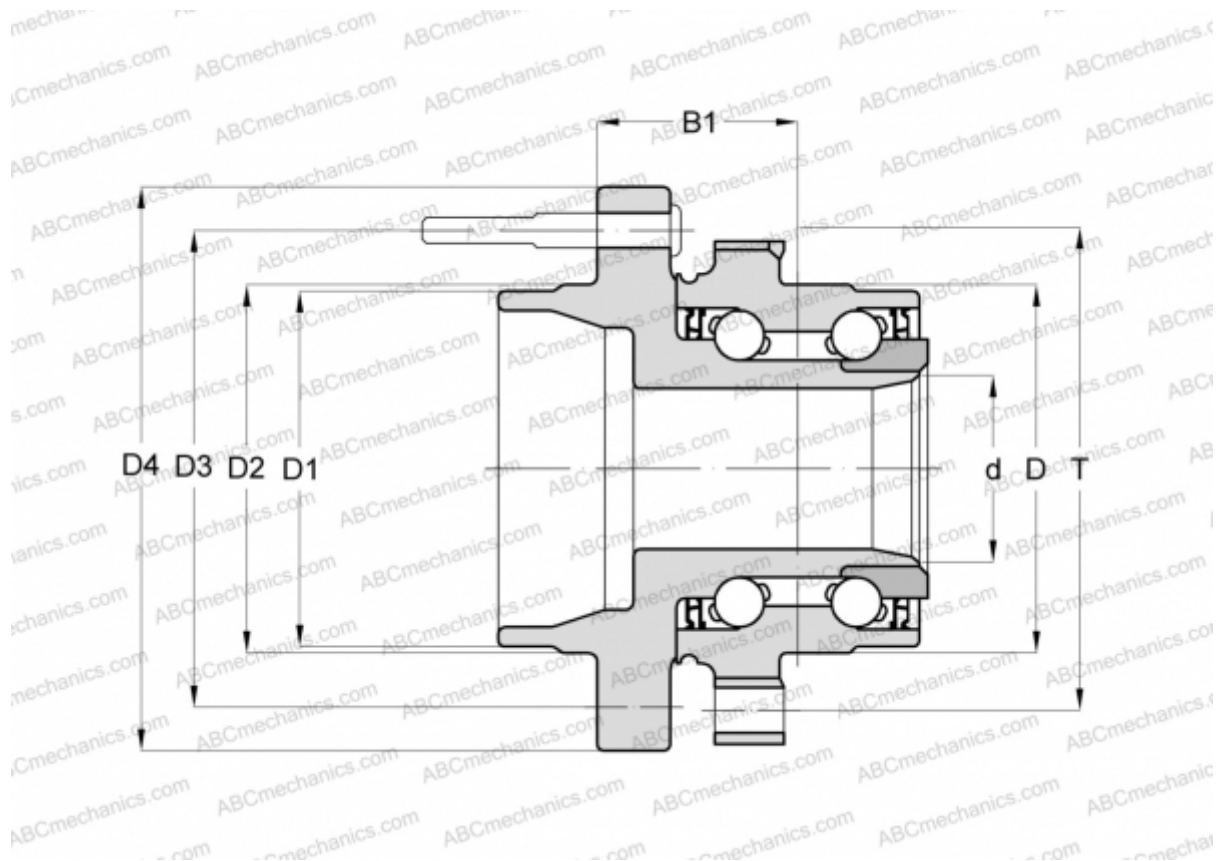

Technical specification

DIMENSIONS, MM

D	83,920
D1	70,000
D2	70,560
D3	114,300
D4	151,000
B1	64,780
T	106,090

MANUFACTURER

[FAG](#)