

102278 FAG

Angular contact ball bearings

TYPE: Ball bearings, Angular contact ball bearing, Double row, Hub bearing (unit), FAG production, generation 3

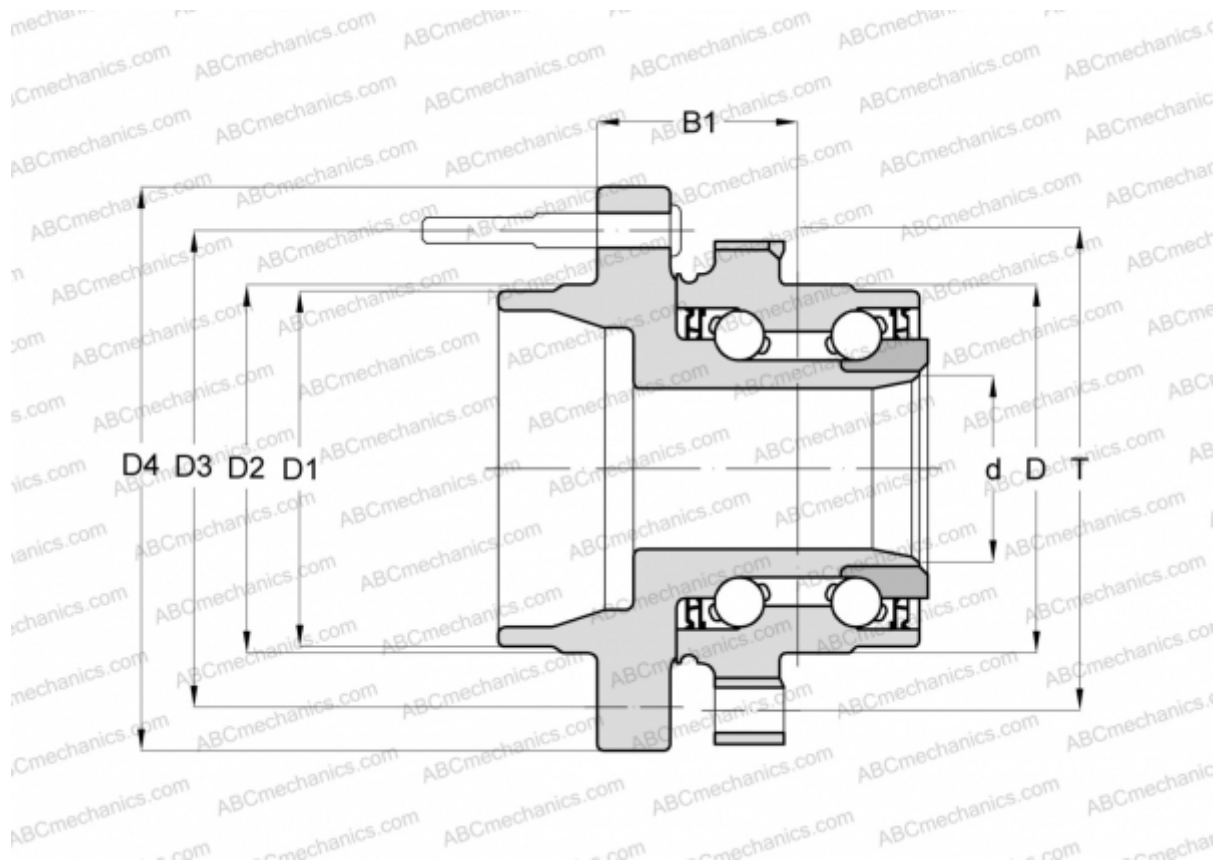

Technical specification

DIMENSIONS, MM

D	76,000
D1	60,000
D2	62,020
D3	114,300
D4	151,900
B1	60,000
T	98,200

MANUFACTURER

[FAG](#)